



Energy Storage System UNIVERSAL 5K3LV/HV

LOW VOLTAGE & **HIGH VOLTAGE**

Installation and User Manual



ATTENTION: The battery can explode under heavy impact.



ATTENTION: The batteries weight exceeds 25kg. Appropriate mechanical lifting equipment must be used.



ATTENTION: The battery can explode and must not be exposed to open flames or other extreme sources of heat



ATTENTION: The battery terminals must be disconnected before commencing any work on the battery.



ATTENTION: This battery can accumulate parasite current. Do not touch the B+ and B- terminals. Always check the B+ and B- terminals with a voltmeter. **Always ensure that there is ZERO volts present on the terminals before performing any operation on the battery.**

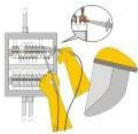

ATTENTION: Always wear Individual protection devices and follow the safety plan of this manual.



This Battery must be recycled by a certified professional company

Contents

SECTION-1: INSTALLATION & PRE-OPERATIONAL PROCEDURES9	
1.1 Module Handling and Lift Out from Box.....	9
1.1.1 Package Information and System Configuration List	10
1.2 Wall Mount or Stack Mount Configuration.....	10
1.2.1 Battery Dimensions.....	10
1.2.2 Wall Mount.....	10
1.2.3 Stack Mount.....	12
1.3 Battery Terminal Function Definition.....	14
1.4 Out of the Box Pre-Operational Check.....	15
 SECTION-2 LOW VOLTAGE CONFIGURATION16	
2.1 Product Introduction.....	16
2.1.1 Identifying the individual module.....	16
2.1.2 Product Identification and labels	17
2.1.3 Accessory List (Standard Kit 120A single module LV).....	17
2.1.4 Necessary Installation Tools	18
2.1.5 Personal Protective Equipment	18
2.2 Low Voltage Module Wiring and Set Up	19
2.2.1 Battery Connections	19
2.2.2 Battery Terminal Definition.....	20
2.3 Low Voltage DIP Switch Settings	20
2.3.1 Stand Alone Battery	21
2.3.2 Parallel Connection (Master + Slave #1)	21
2.3.3 Parallel Connection (Master + Slave #1 + Slave #2)	21
2.3.4 Parallel Connection (Master + Slave #1 + Slave #2 + Slave #3).....	21
2.3.5 Parallel Connection (Master + Slave #1 + Slave #2 + Slave #3 + up to slave #7)	21
2.4 Parallel Battery Wiring Connections	22
2.4.1 Low Voltage Single Stack Power and Data Connections (8-Modules)	23
2.5 Module Activation and Shutdown.....	25
2.5.1 LED Visual Indication Lights	25
2.5.2 Stand Alone Battery Front Panel Control.....	27
2.5.3 Parallel Battery Configuration	27
2.6 LV Product Compatibility List + Maximum Modules Permitted per Cluster	29
2.6.1 Direct Parallel with CAN Communication	29
2.6.2 LV Direct Parallel Without BMS Communication with Inverter	30

2.7	Overview of Multi Cluster System	31
2.8	CAN Hub for Multi Cluster Configuration.....	32
2.8.1	CAN Hub Dimensions.....	34
2.8.2	Control Logic and Protection Limit.....	35
2.8.3	CAN Hub General System Description.....	36
2.8.4	Multi Cluster Configurations.....	38
2.8.5	Cluster Configuration Accessories.....	41
2.8.6	Inverters with no Communication Facility.....	42

SECTION-3 HIGH VOLTAGE CONFIGURATION.....44

3.1	Product Introduction.....	44
3.1.1	Identifying the Individual Module.....	45
3.1.2	Product Identification and labels.....	45
3.1.3	Accessory List (Standard Kit).....	46
3.1.4	Necessary Installation Tools.....	46
3.1.5	Personal protective equipment.....	47
3.2	High Voltage Module Wiring and Set Up.....	48
3.2.1	Battery Connections.....	48
3.2.2	Battery Terminal Definition.....	49
3.3	High Voltage Module Configuration – HV Box 750Vdc.....	50
3.4	High Voltage DIP Switch Settings.....	51
3.4.1	Serial Tower Connection #1 Set Up of the HV box CAN Communication Loop.....	52
3.5	Serial Battery Wiring Connections.....	53
3.5.1	High Voltage Power Connections (12-Modules).....	54
3.5.2	DATA Connections (Example of 12-Modules).....	55
3.5.3	HV BOX Connections.....	59
3.6	Module Activation and Shutdown.....	65
3.6.1	LED Visual Indication Lights.....	65
3.6.2	Stand Alone Battery Front Panel Control.....	66
3.7	HV Product Compatibility List + Maximum Modules Admitted per Cluster.....	68
3.7.1	Direct Serial with CAN Communications.....	68
3.7.2	Direct Connection without CAN Communications.....	69

Statement:

The information and guidance contained in this manual is related to the WeCo 5K3 – LV – HV Stackable model of battery
 This manual contains two sections:

Section 02 is for LOW VOLTAGE APPLICATION

Section 03 is for HIGH VOLTAGE APPLICATION

In case of product upgrades or other reasons, this document will be adjusted accordingly. Unless otherwise agreed, this document is intended to be used only as a guide, and all statements, information and advice in the documentation shall not constitute any express or implied action in contradiction to local regulations or standards.

For more information, please contact us.

The official information and the latest datasheet are available on www.wecobatteries.com.

It is essential that the battery unit is equipped with the latest firmware version available.

New batteries always ship with the latest version of firmware.

WeCo will release new firmware to improve the functionalities and battery capabilities from time to time.
 The latest version of the firmware is always available free of charge and can be updated by your local installer.
 You can also write an email to service@weco.uk.com to understand the upgrade procedure.



ATTENTION

This battery model is designed to be used indoors
 The STANDARD IP20 degree of protection does not allow installation in outdoor environments even if sheltered from the weather.
 The INDOOR definition means literally the internal environment, the room must be closed to unauthorized persons, Ventilated and dry.

IMPORTANT NOTICE

Thank you for choosing our product. We will provide you with a high-quality product as well as reliable after service.
 To protect against harm to both personnel and the product, please read this manual carefully.
 This manual provides detailed information on operation, maintenance and troubleshooting of the product as well as health and safety advice.
 To benefit from the 10-year performance guarantee, the battery must be used under the STC * standard test conditions and the battery must be connected via CAN BUS and one of the WeCo approved inverters. Failure to connect the battery via CAN and use in environmental conditions and with charge and discharge currents exceeding the STC values exclude the product from the 10 year performance guarantee



Special Announcement:

The manufacturer holds the right of final explanation of any content in this manual.

SYSTEM DESIGN

Systems Design is the process of defining the architecture, components, modules, interfaces, and load data for a system to satisfy specified requirements.

For a solar system these components are the PV modules, inverter/charge controller & batteries, as well as the different interfaces of those components.

BATTERY OPERATION

There are several factors that affect the operation of the battery concerning its ability to deliver capacity and life expectancy.

Storage

Module properly packed into original DG9 carton box to be stored indoors in a clean, level, dry, cool location.

Recommended storage temperature is 25°C

The Battery can be stored in the range of -20°C + 45°C but it is required an inspection and recharge every three months (max charging current is 0.1C)

Max SoC storage % is 50%

Temperature

Many chemical reactions are effected by temperature, and this is true of the reaction that occurs in a storage battery. The chemical reaction of a Li-Ion is slowed down by a lowering of the electrolyte temperature that results in less capacity.

A battery that will deliver 100% of rated capacity at 25°C will only deliver approximately 75% of rated capacity at 10°C. At temperatures below -7°C the BMS will allow only 0.1C charging Current below -7°C the charge is forbidden.

As part of the performance Warranty, Charge and Discharge shall be in the range 20-25°C 0,5C any usage outside this range is not covered by Performance Warranty

Depth of Discharge (DoD)

Depth of discharge is a function of design. The deeper the discharge per cycle, the shorter the life of the battery. A cycle is a discharge and its subsequent recharge regardless of depth of discharge.

The number of cycles at a specific DoD and the projected life in years the battery / battery system will provide prior to needing replacement.

Charging

Majority of battery capacity/life issues can be traced to improper charging. Improper charging settings may lead to an overcharging or undercharging condition.

WeCo guarantee only batteries connected via BMS line to the Approved inverter

Typical Inverters/Charge Controllers are equipped with CAN/BMS interface ad no settings are required to charge and discharge the battery.

Warranty

Although the BMS of the battery allows a wide range of use both in terms of temperature and charging currents, this should not be construed as an implicit authorization to use the battery at these levels.

For the purposes of the performance guarantee, it is mandatory that the battery is used within the range of temperature and charge / discharge current and Depth of Discharge indicated in the performance guarantee.

Any other use, even if permitted by the BMS ranges, is not covered by a performance guarantee

Product Overview

WeCo'S 5k3 LV HV Stackable Module is a DUAL VOLTAGE module that can be used in a Low Voltage configuration or in a High Voltage configuration.

For LOW VOLTAGE (48-58Vdc) Configuration Refer to Section-2

For HIGH VOLTAGE (150-750Vdc) Configuration Refer to Section-3

The 5K3 LV-HV Stackable module is designed for home and commercial applications from 5 kWh up to 132 kWh in Low Voltage configuration and from 20 kWh up to 680kWh in High Voltage configuration

INFORMATION IN THIS MANUAL

About this Manual

This manual relates only to the WeCo 5k3 LV-HV Stackable Model. This manual is intended to be used only by qualified installers who must read carefully and always refer to the manual for guidance on correct operation and maintenance of the product.

Use Range

This installation guidance applies for the High Voltage and Low Voltage Inverters.

Make sure to identify the correct inverter charging parameters before connecting to the battery.

Each 5k3 LV-HV module has two different circuits and according with the inverter voltage range the installer must choose the correct battery configuration for the inverter voltage range.

Additional Information

Specification of the product can be changed without any notice to customers for system improvements.

Symbols Used

Symbol Meanings:



CAUTION:

CAUTION represents hazardous situations which can cause light injuries if not avoided.



NOTICE:

NOTICE represents the situations which can cause damage to property if not avoided.



INFORMATION:

INFORMATION provides tips that are valuable for optimum installation and operation of the product.

Warnings and Notification

Installation environment requirements: The 5k3 LV-HV Stackable module is designed for household/commercial purposes. For installation, it must be installed in a location complying with IP20 (IP 55 or 65 are available on request). Installations in locations that do not comply with IP20 may cause failure and/or damage to the product and subsequently the product warranty will be considered void and no responsibility will be accepted for any related accident or damage.

Safety Guidelines



CAUTION:

At all times be certain to avoid a short-circuit between the anode terminal and a cathode terminal of the battery. All electrical connections on the 5K3 LV-HV module must be made only by qualified professional personnel.

When installed and operated in accordance with this manual, the 5K3 LV-HV module will perform in a safe and reliable manner in accordance with the battery operating specifications.

Subjecting the battery to an unsuitable operating environment or to damage, misuse or abuse may result in health and safety risks such as overheating or electrolyte smoke potential. All personnel must comply with the safety precautions and observe all warnings as detailed in this document. If any of the safety precautions or procedures detailed in this manual is not fully understood by the reader, the reader must not perform any operation on the battery, until they have contacted the WeCo customer service officer for clarification and confirmation of understanding of the correct procedure.

The safety guidelines included in this document may not include or consider all the regulations in your area of installation/operation. When installing and operating this product the installer must review and consider applicable local laws and regulations in accordance with the industry standards of the product.

Installation personnel shall not wear watches and other metal items when performing installations as a precaution to avoid short circuits and personal injuries.



CAUTION:

The weight of an individual 5k3 LV-HV module is over 50kg, please use original packaging and perform all safety precautions if the battery is to be relocated to another location, to avoid damage to the product and personnel injury.



ATTENTION

The high voltage configuration must have a minimum number of 4 modules in order to reach at least 200Vdc in series.

The maximum number of modules that can be stacked is 6 on each tower (due of the tower height and stability)

The maximum Voltage string series in HV configuration depends by the HV BOX Version

Version A is 750Vdc

Version B is 950Vdc



ATTENTION

The stack configuration shall be concluded by interlocking the modules by using the module feet as shown below

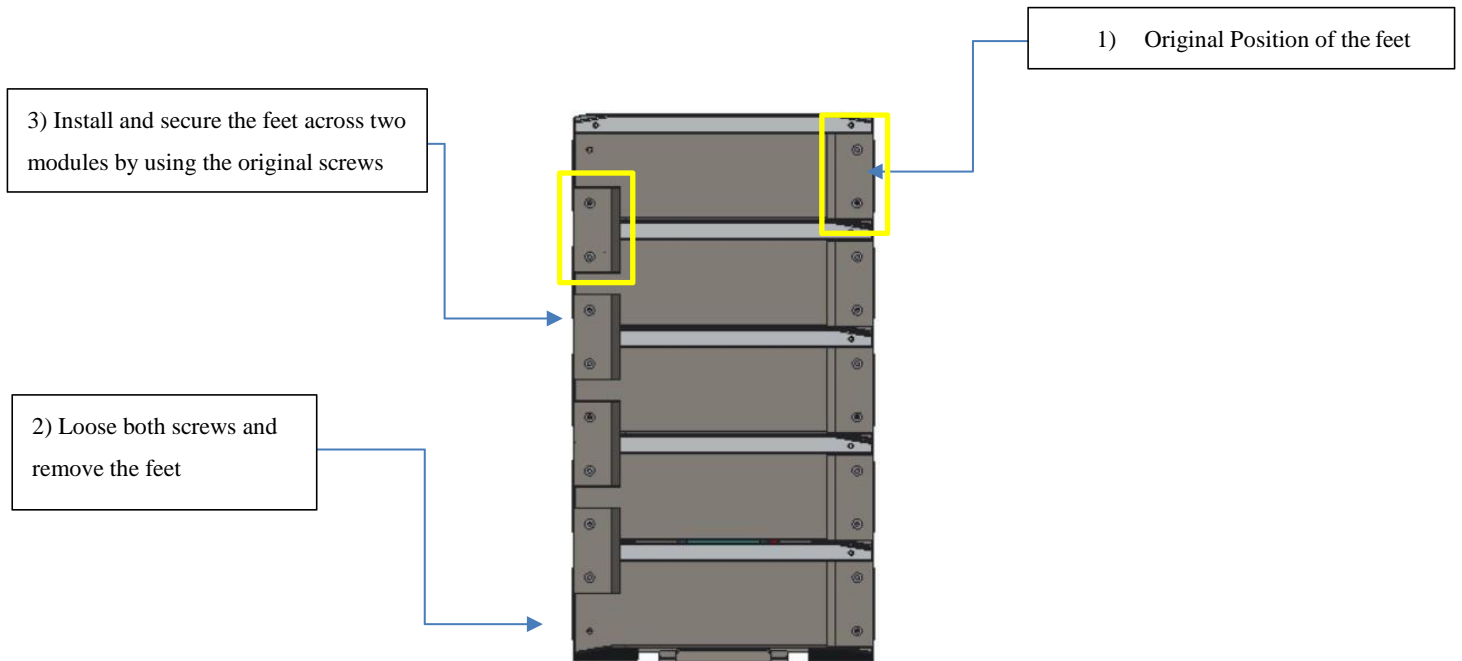

GENERAL PREPARATION

Before Installation

Ensure that all the modules are turned OFF

Battery installation location should be at least 20m away from sources of heat, sparks or other sources of extreme temperature. Battery connecting cables should be as short as possible to prevent excessive voltage drops..

Batteries with different capacity, different type/model or design or from different manufacturers cannot be connected together.

- 1. Before connecting the battery, the battery positive and negative poles need to be carefully checked to ensure correct installation.**
- 2. The installation location must be on a flat ground, in a dry clean and protected room, away from water and humidity.**

The mechanical installation method for the 5K3 LV-HV modules can be considered "conceptually" the same for HV and LV configurations

The installer who intends to install the 5K3 LV-HV module in the HV configuration shall read this entire manual including the HV configuration information included in Section-3 of this manual

SECTION-1: STORAGE & PRE-OPERATIONAL PROCEDURES

1.1 Storage - Transportation – Removing / relocation of batteries

- ✓ This Battery is considered DANGEROUS GOODS by the United Nation and must be treated accordingly
- ✓ Each box comes from the factory with the below labels
- ✓



- ✓ This battery can only be transported and stored with the original approved Carton Box, Certified as per UN CLASS 9 Y80
- ✓ This Battery must be stored in its original carton box in a dry and cool place, WeCo carton box are marked as below



- ✓ The transportation and Storage SoC shall not exceed 50%
- ✓ The Shelf period without recharging is 6 months, it is required a quick charge up to 70% DoD and discharge back to 50% at 0.5C /25°C
- ✓ To preserve the performance the shelf life of this battery store at 25°C 70% Humidity
- ✓ Optimal Storage temperature of the battery is between 15°C and 35°C
- ✓ The self-Discharge in the range of 15-35°C is around 1% a month, outside this range could exceed 10% a month.
- ✓ Do not store the batteries near sources of heat, vapor, Gas, Fuels, Sparks or anything that could generate fire or explosion.
- ✓ Store inside and protect from water and moisture.
- ✓ Transportation of new and used or damaged modules must be in accordance with the UN 38.3 Regulation and with the local rules
- ✓ If one or more working units needs to be removed or relocated this must be marked as **USED BATTERY** (follow local rules)
- ✓ If one or more modules need to be replaced due to damage, they should be marked as **DAMAGED USED BATTERY** and take any applicable procedures for location and local regulations.

1.2 Module Handling and Lift Out from Box

The battery is always delivered in WALL mode and it is therefore necessary for the installer to make simple changes to install the STACK kit. Below are the installation phases.



ATTENTION

The battery must be lift by 4 persons by using the 4 handles

2 Handles are inbuilt and the other two are provided as temporary handles to be used as shown below

Open the carton box, find the portable and retractable handles, position them and proceed with the lifting up.

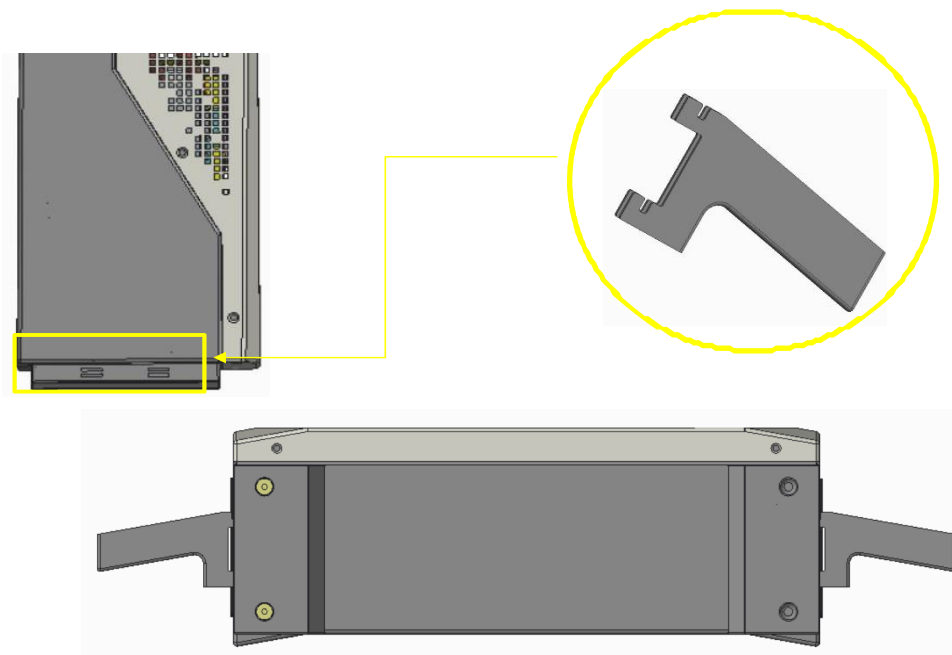

1.2.1 Package Information and System Configuration List

The battery box is packed in cartons with accessories.

When you receive the goods, please read the configuration list carefully to make sure that the battery box and accessories are received in the correct quantities and type and visually inspect to ensure that they are free from damage.

Refer to Section 2.1.3 for Low Voltage packing list and to Section 3.1.3 for High Voltage packing list.

1.3 Wall Mount or Stack Mount Configuration



NOTE: The LV/HV 5K3 battery module ships as standard in the wall mount configuration.

1.3.1 Battery Dimensions

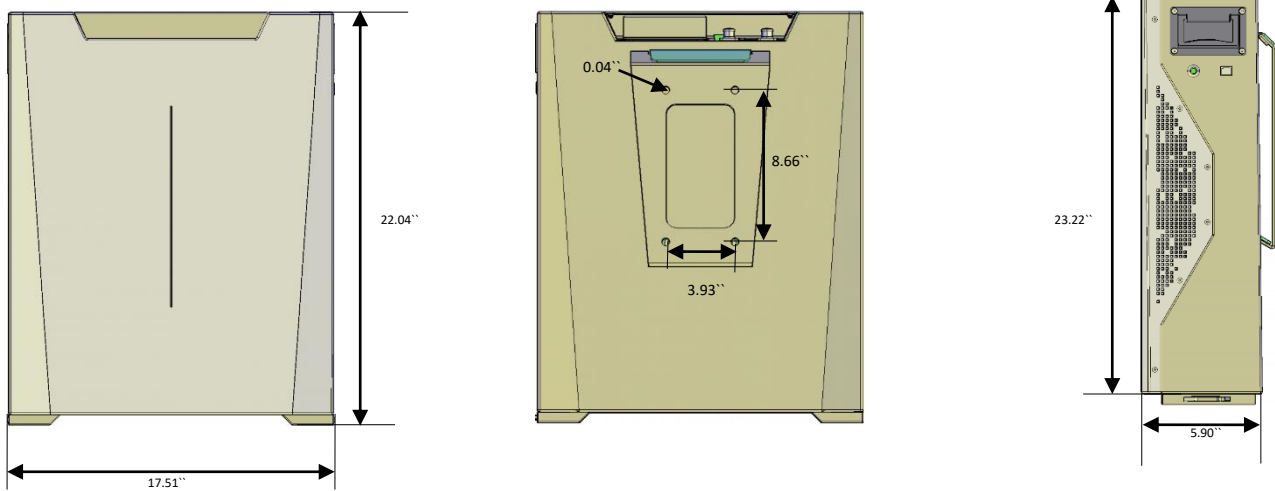

1.3.2 Wall Mount

Step 01: Install the wall bracket by using the wall plugs and screws contained in the battery kit.

The wall must be inspected before proceeding with the bracket installation, a local civil engineer should assess the correct installation method.

STEP 01

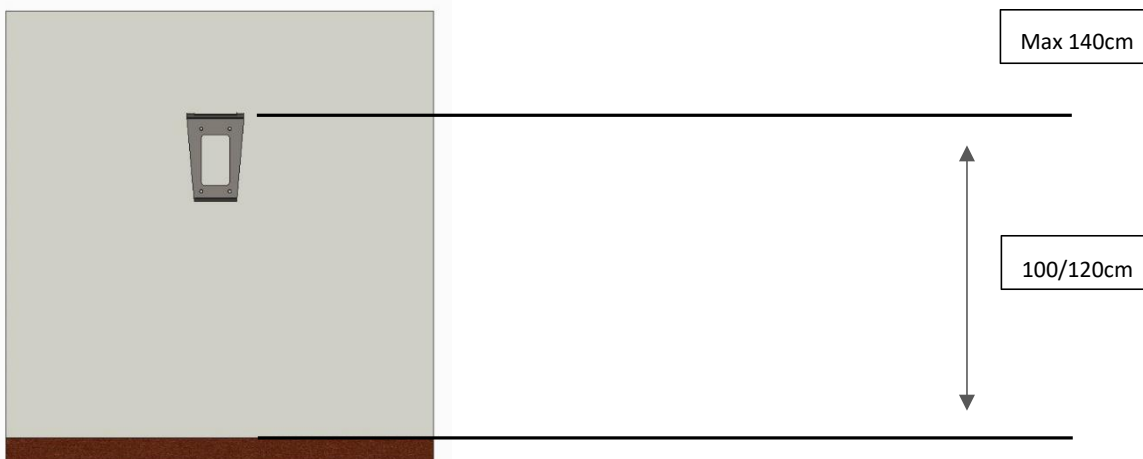



ATTENTION

The battery weighs more than 52kg and must be installed with the help of a mechanical lift, and/or with at least two people equipped with suitable suction cups for mechanical lifting or lifting straps

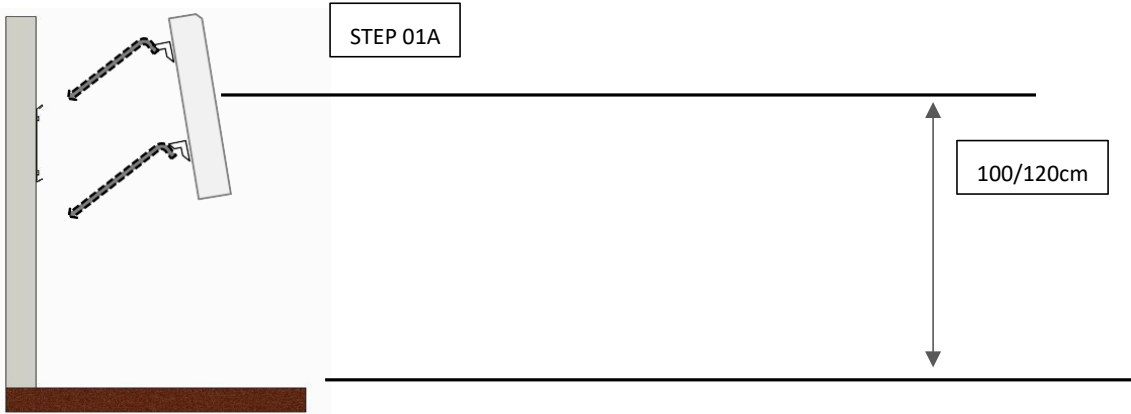

The Bracket must be installed on a flat and vertical wall.

The steel bracket must be flush to the wall without any empty spaces between the wall surface and the back side of the bracket.

Make sure to have adequate space to install the battery before proceeding with the installation.

Step 02: Install the battery by fitting the back bracket of the module with the wall bracket interlocking

This operation must be conducted with a mechanical lifting device and/or with at least three specialized installers

Make the battery module is stable and properly locked into the upper interlocking plug

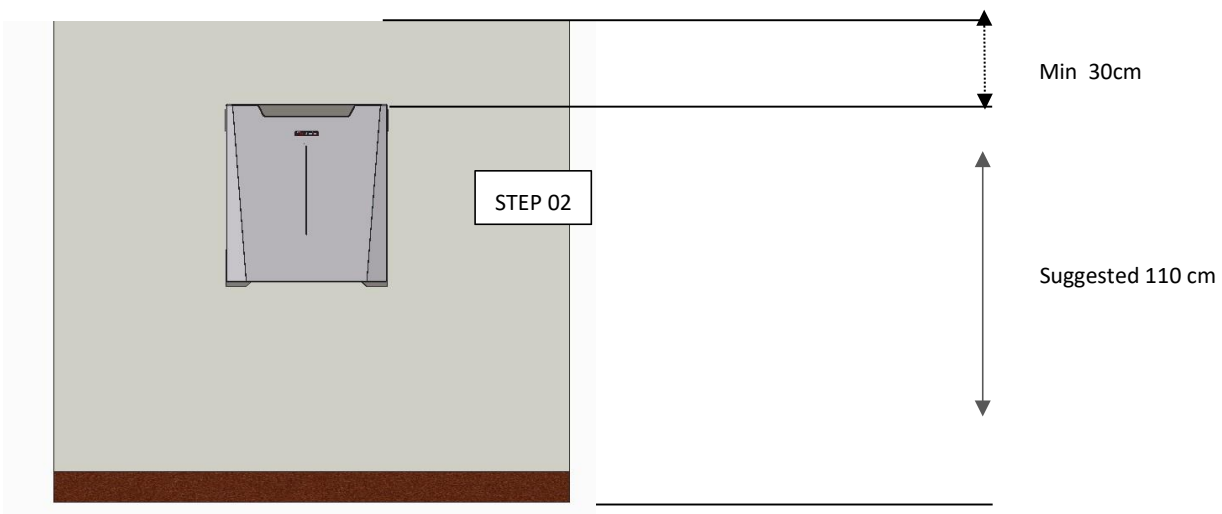

Step 2a: In case of multiple module installation make sure to respect the distance between the modules and the ceiling.

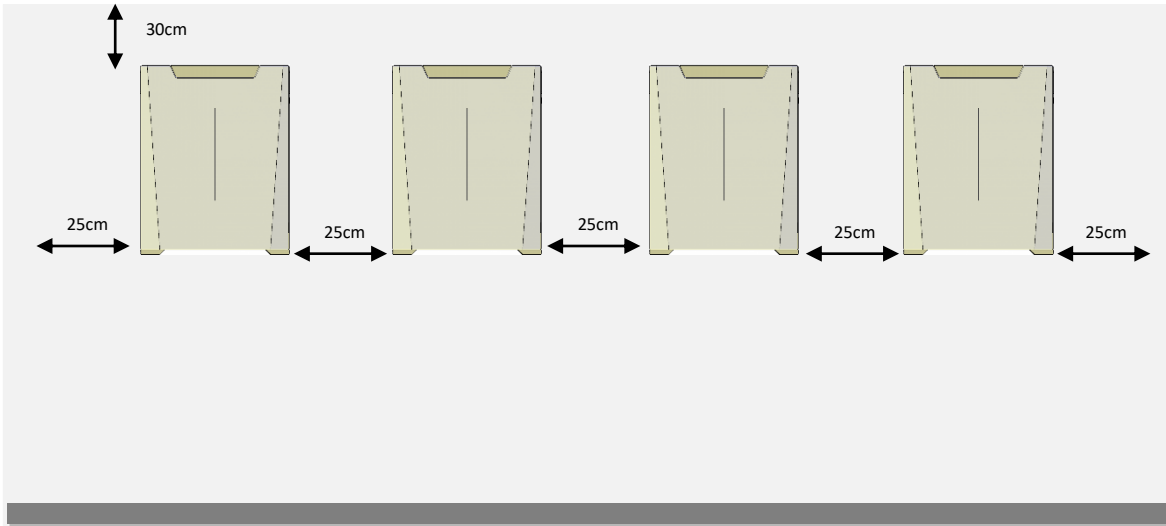

1.3.3 Stack Mount



ATTENTION

The battery weighs more than 52kg and must be installed with the help of a mechanical lift, and/or with at least two people equipped with suitable suction cups for mechanical lifting or lifting straps.

As previously stated in this manual, the 5K3 module comes as standard in wall mount configuration.

To install in the Stackable configuration, the screws on the back of the battery module must be removed.

1. Remove the back-side wall support plate using an Allan Key. The plate has 5 screws.

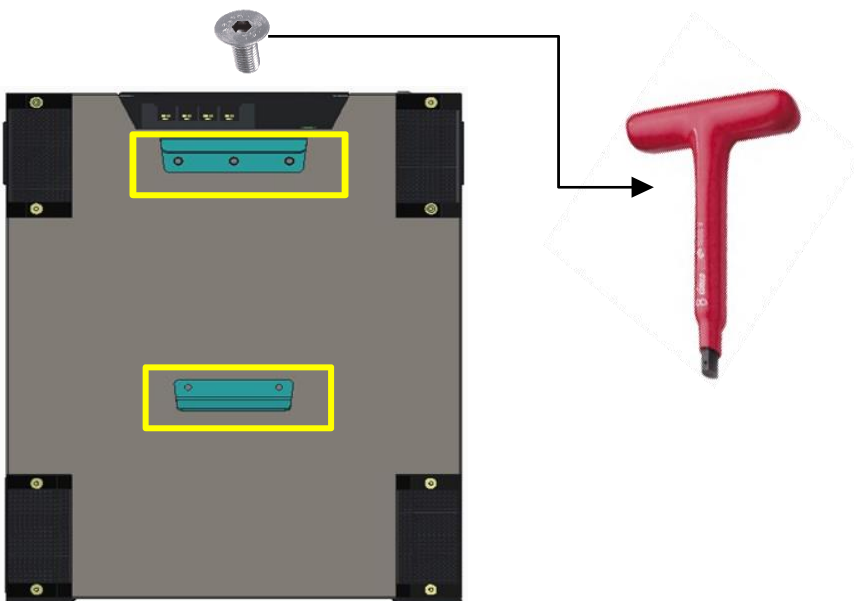

- 2. Once the wall bracket support has been removed, start stacking the second module on top of the first module laid on the ground by using the front retractable handles.

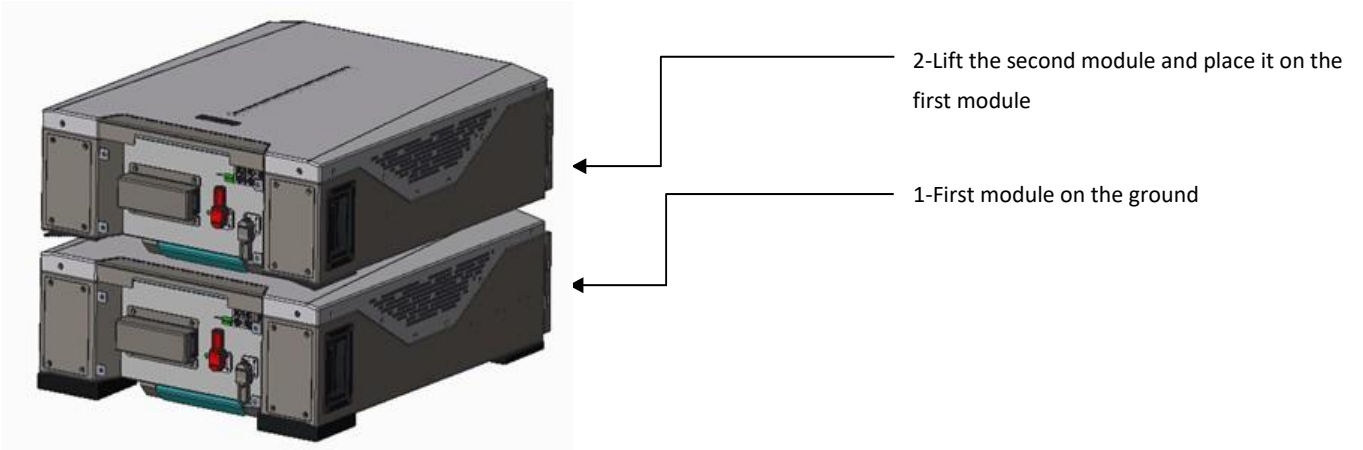

 **ATTENTION**

Before stacking the batteries the installer must check the maximum permissible floor load. WeCo recommends that the installer obtains approval from a civil engineer.

For vertical ground mounted the support surface of the battery is distributed on 4 feet 10x4 cm, make sure to install a distribution plate or make a proper foundation to support the weight.

In case of horizontal installation, the installer must prepare an adequate distribution plate on the floor in order to make a safe and stable support for the pile of batteries.

Make sure the support and/or the floor surface is adequate to support the battery load.

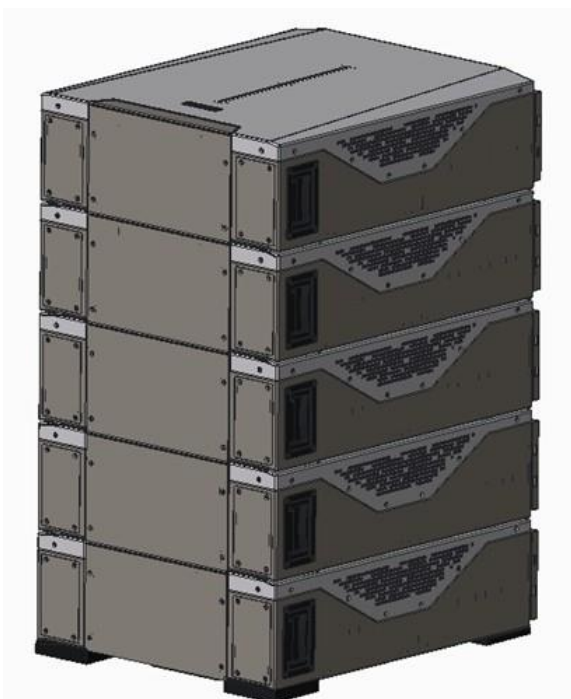

- ↓ 265 Kg
- ↓ 212 Kg
- ↓ 159 Kg
- ↓ 106 Kg
- ↓ 53 Kg



1.4 Battery Terminal Function Definition

The terminal layout is shown in the following figure:

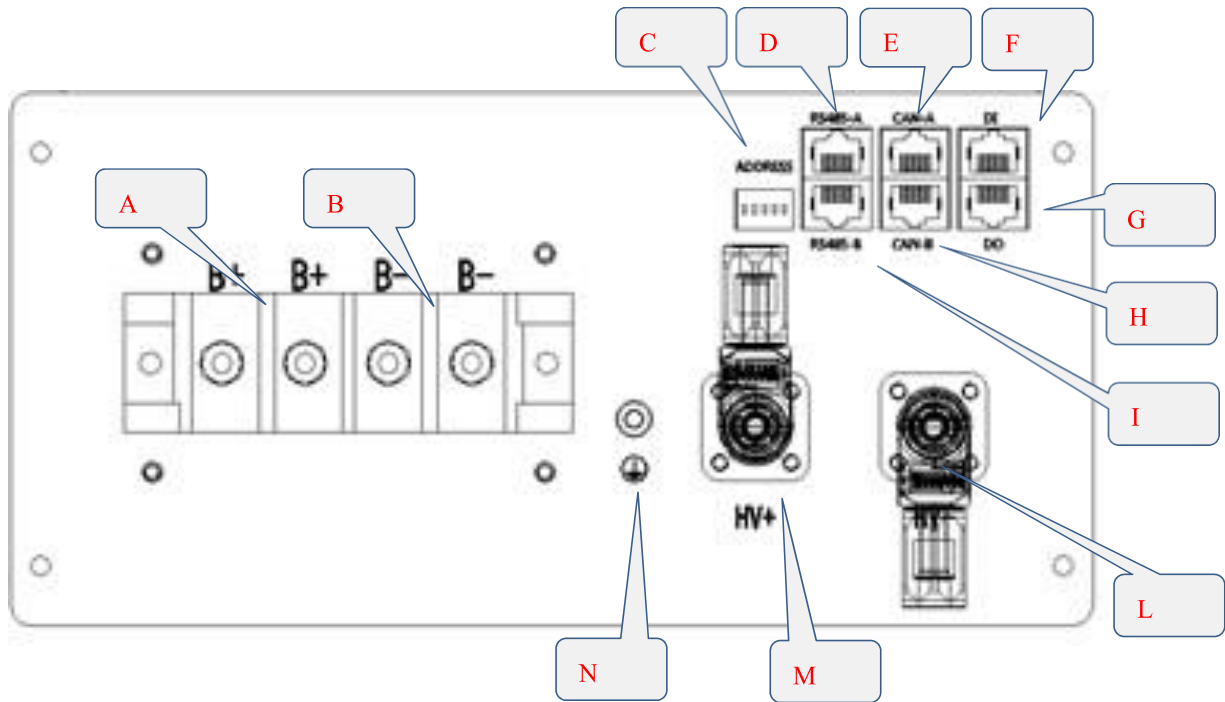

LOW VOLTAGE Wiring definition table

Interface	Name	Function
A	LV POLE +	LOW VOLTAGE POSITIVE (+) Screw Terminal
B	LV POLE -	LOW VOLTAGE NEGATIVE (-) Screw Terminal
C	DIP SWITCH	DIP SWITCH Address HUB 8 PINS (LV PARALLEL ID SET UP and HV ADDRESS PATH)
D	RS 485 A LV	LOW VOLTAGE COMMUNICATION PORT RS 485
E	CAN A	CAN – BMS to LOW VOLTAGE INVERTER
F	D/I	Digital Input
G	D/O	Digital Output
H	CAN B	HIGH VOLTAGE SERIAL IDENTIFIER RJ45 CAN PORT
I	RS 485 LV	LOW VOLTAGE COMMUNICATION PORT RS485
L	HV POLE -	HIGH VOLTAGE POSITIVE (+) Fast Connector Terminal for serial connection
M	HV POLE +	HIGH VOLTAGE NEGATIVE (-) Fast connector Terminal for serial connection
N	GND	Ground terminal

Attention: Interface E: RJ45 port corresponding to the CAN bus pin definition

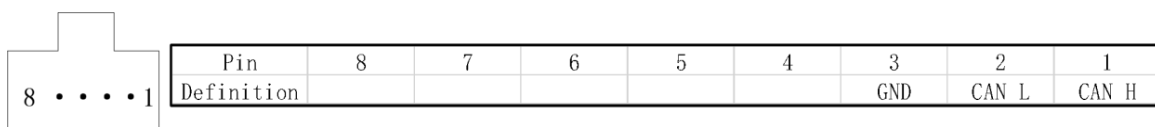

1.5 Out of the Box Pre-Operational Check

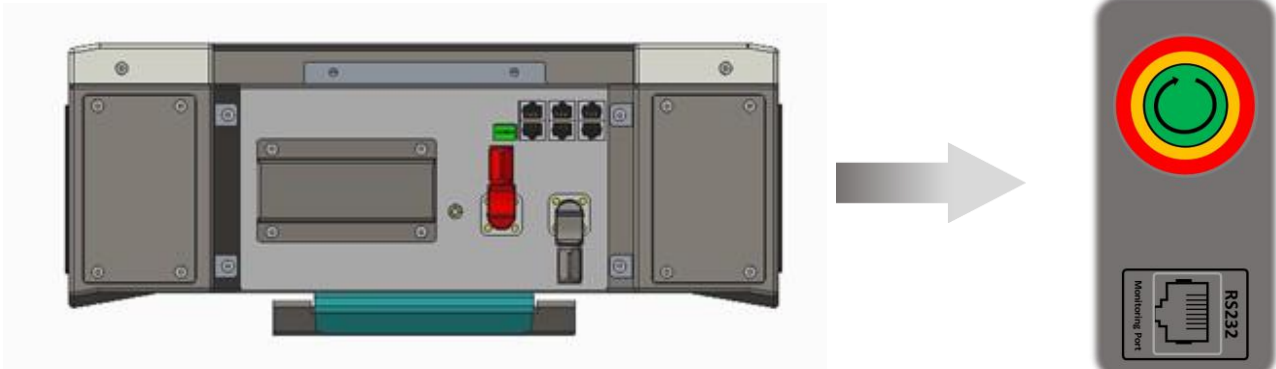

Attention: Do not make any connection to the battery until you have thoroughly read and understood this entire manual.

The Power Button is located on the right side of the battery as shown above. The Power Button is a multi-colored button.

Pressing the Power Button for 2 seconds will initiate the start up process of the battery.

The Power Button will settle as a steady green color if the battery is operating correctly.

If the battery is low on charge the Power Button will display a steady yellow color.

If the Power Button displays a flashing red color there is a fault and you should not attempt any further operation of the battery and contact WeCo support on service@weco.uk.com.

There is also an RS232 monitoring Port which will allow you to check all parameters of the battery module. Full instruction on how to interface to the RS232 Port can be found in this manual.



Attention: At this stage, after you have determined that the battery is functioning correctly, it is mandatory to switch the battery off and follow the instructions and guidance in this manual very carefully before attempting any configuration or connection to the battery module.

To switch the battery of (shutdown the battery) simply press Start/Stop button for 5-seconds and the green LED will go off, confirming that they battery has shutdown correctly.



Attention: Read this manual thoroughly and always follow the guidance in this manual before and while performing any installation procedure.

SECTION 02 LOW VOLTAGE CONFIGURATION

SECTION-2 LOW VOLTAGE CONFIGURATION

2.1 Product Introduction

The 5K3 LV-HV modules can be used as an on-grid or off-grid energy storage system. It is not recommended to use this product for any purpose other than the intended purpose as described in this document.

Use of this product other than as described in this document will nullify the product guarantee. The substitution or installation of any components of this battery will nullify the product guarantee.

The use of any components contained within or connected to this battery other than the products sold as part of this product or recommended by the manufacturer will nullify the product guarantee.

Connecting more than five individual 5K3 LV-HV modules in parallel will nullify the product guarantee.

2.1.1 Identifying the individual module

Dimensions	mm	510x550x150
Weight	kg	52
Case material	Type	Steel
Parallel Units	N°	5
Stackable	Type	Yes
Digital Output	N°	2

Dimensions	mm	510x550x150
Weight	kg	52
Case material	Type	Steel
Parallel Units	N°	5
Stackable	Type	Yes
Digital Output	N°	2

Cell Type	ID	LiFePO4
Cells Distribution	P/S	16S
BMS charge Temp.	°C	-10°C +55°C
BMS Disch. Temp.	°C	-25°C +65°C
Storage Time/Temp.	°C	-20°C +45°C 4months
Self Disch Time/Temp.	%	3% month @25°C

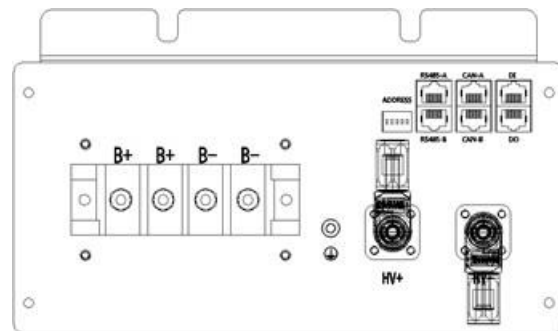

2.1.2 Product Identification and labels

The nameplate label describes the product parameters and is attached to the product. For details, please refer to the nameplate label of the product. For safety reasons, the installer must have a thorough understanding of the contents of this manual before installing the product.

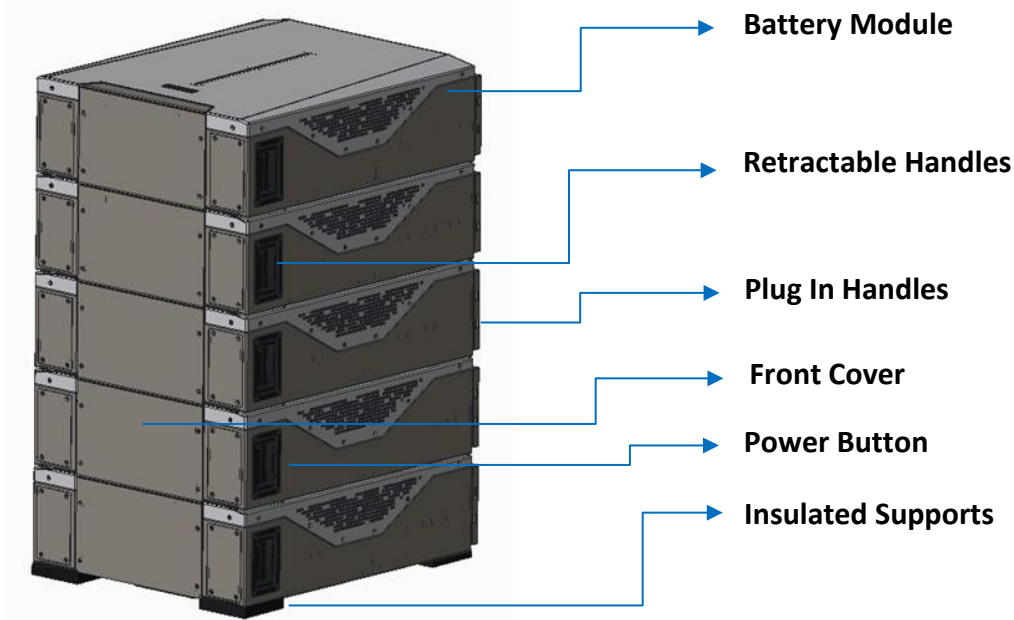









2.1.3 Accessory List (Standard Kit 120A single module LV).

The battery is packed in a carton together with standard accessories. When unpacking the battery, be sure to check that the battery and accessories are free from damage and that the correct quantities of each component are included within the carton.

The following list of components can be used as a check list when unpacking the individual battery and battery kits.

Number	Name	Quantity	Description	Image
1	Power Cable	2	2x25mm ² AWG cable 2.5 (m) each Red/Black	
2	CAN cable RJ45 Parallel Connection	1	100cm	
3	Earthing Screw	1	M5 Allen key	
4	BMS/STD	1	1 BMS std Cable 100cm	

2.1.4 Necessary Installation Tools

 <p>Multimeter + Current clamp</p>	 <p>Screw Driver Set</p>	 <p>Allen Key Set</p>	 <p>Drill + Hammer</p>
 <p>Electrician Scissors</p>	 <p>Wrench set</p>	 <p>Lifting strap + mechanical lifter</p>	 <p>RS 232/USB+screw terminal (insulated)</p>

2.1.5 Personal Protective Equipment



2.2 Low Voltage Module Wiring and Set Up

2.2.1 Battery Connections

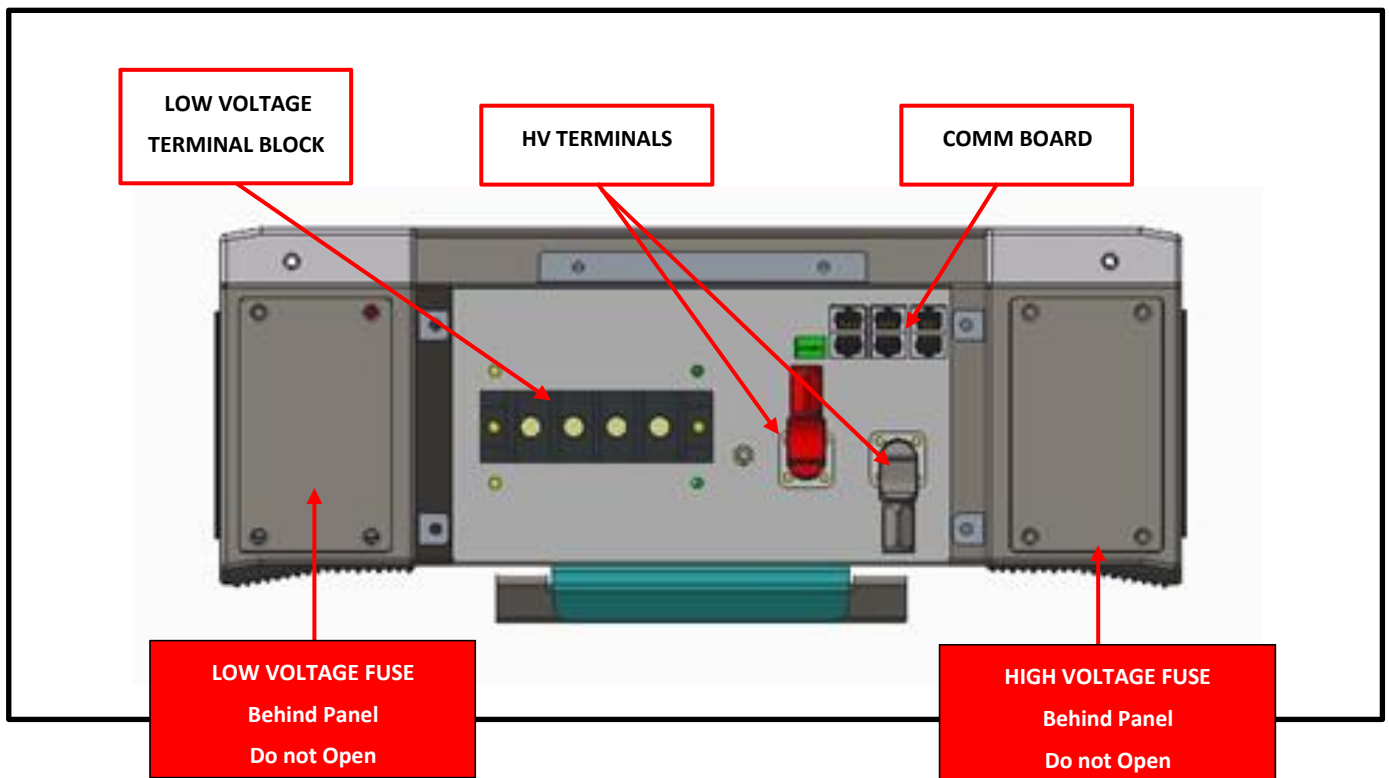
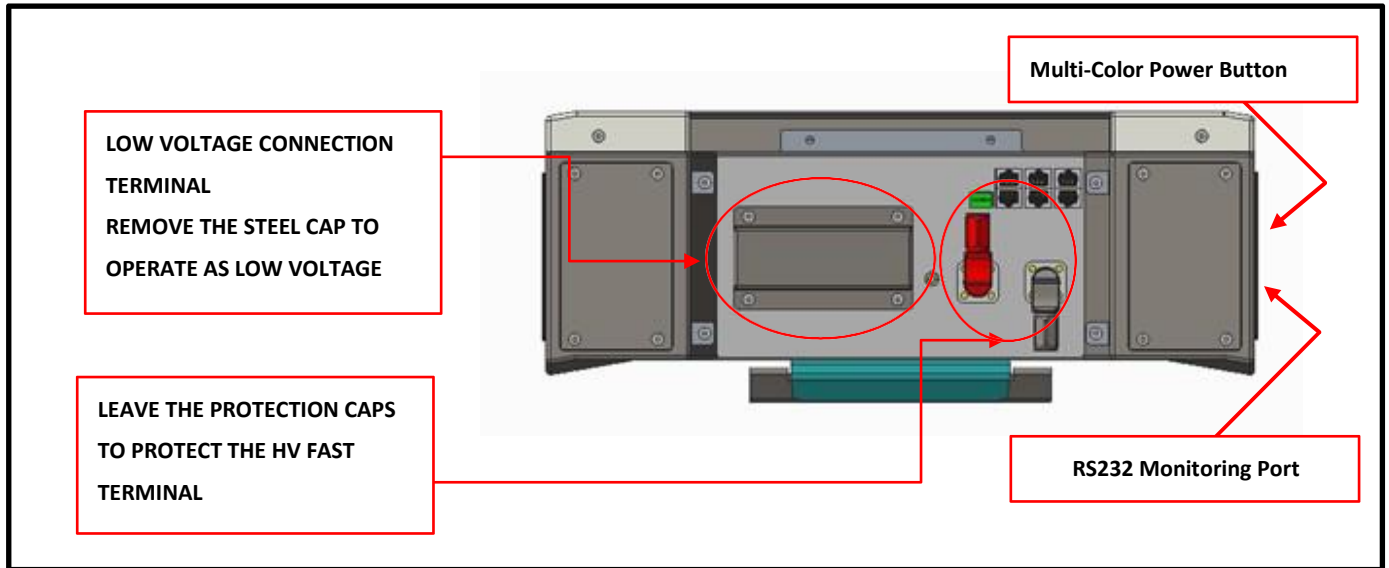

CAUTION: The LV fuse is contained in the left portion of the module as shown above.

The access to the fuse is restricted to the WeCo assistance team and the protection lid cannot be opened by anyone apart from WeCo. The same applies to the HV fuse.

2.2.2 CAN PIN OUT

The terminal layout is shown in the following figure:

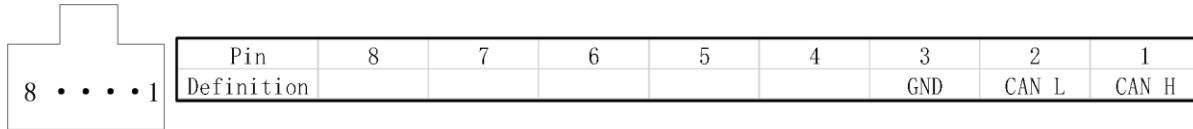

2.3 Low Voltage DIP Switch Settings



ATTENTION



ALWAYS CONFIGURE THE DIP SWITCH SETTINGS BEFORE CONNECTING ANY POWER CABLES TO THE BATTERY TERMINALS B+ AND B-.



WHEN CHANGES HAVE BEEN MADE TO DIP SWITCH SETTINGS THE BATTERIES MUST ALWAYS BE RESTARTED FOR THE CHANGES TO TAKE EFFECT.



POWER CABLE CONNECTIONS MUST BE MADE IN STRICT ACCORDANCE WITH THE INSTRUCTIONS IN THIS MANUAL. INCORRECT POWER CONNECTIONS CAN DAMAGE THE BATTERY AND CAUSE INJURIES



WHEN THE INVERTER HAS A CANBUS COMMUNICATION PORT SWITCH#7 OF THE MASTER BATTERY MUST ALWAYS BE SET TO "ON".



Attention: All drawings are for reference only, always refer to the physical product as the standard. If the manual does not match the physical product stop all actions, remove any connections and store the batteries in a safe place, call WeCo product assistance for support.



2.3.1 LOW VOLTAGE PARALLEL CONFIGURATION

The DIP switch must be set as follows to allow a single battery module to communicate with an inverter using CAN communications:

DIP CONFIGURATION UP TO EIGHT MODULES IN PARALLEL



CAUTION: After setting the DIP switch the battery must be restarted for the DIP switch changes to take effect



Master



Master



Slave 1



Master



Slave 1



Slave 2



Master



Slave 1



Slave 2



Slave 3



Master



Slave 1



Slave 2



Slave 3



Slave 4



Master



Slave 1



Slave 2



Slave 3



Slave 4



Slave 5



Master



Slave 1



Slave 2



Slave 3



Slave 4



Slave 5



Slave 6



Master



Slave 1



Slave 2



Slave 3



Slave 4



Slave 5



Slave 6



Slave 7





CAUTION: After setting the DIP switches the batteries must be restarted for the DIP switch changes to take effect

2.4 Parallel Battery Wiring Connections



ATTENTION



POWER CABLE CONNECTIONS MUST BE MADE IN STRICT ACCORDANCE WITH THE INSTRUCTIONS IN THIS MANUAL. INCORRECT POWER CONNECTIONS CAN DAMAGE THE BATTERY AND CAUSE INJURIES



40 Nm Power Cable Tighten

CHECK TORQUE EVERY THREE MONTHS



Attention: Screws, Cables and Bus Bar POWER CONNECTIONS must be installed with due diligence and the tightening of the connection terminal must be to 40Nm. Each terminal should be inspected and its torque checked every 3 months



Attention: All drawings are for reference only, always refer to the physical product as the standard. If the manual does not match the physical product stop all actions, remove any connections and store the batteries in a safe place, call WeCo product assistance for support



Attention: Power cable connection For High current connection diagram please refer to the specific section, charging current limitation is mandatory as per this manual instruction.

2.4.1 Low Voltage Single Stack Power and Data Connections (5-Modules)

- 2.4.1.1 Proceed with the physical installation of the desired quantity and configuration of the battery modules following the installation sequences and guidelines as described Section-1 of this manual.
- 2.4.1.2 Connect the power cables as indicated below, making sure that the batteries are **OFF** (check the button LED on the bottom) and always measure the terminals with a multimeter to check for **ZERO VOLTS**.

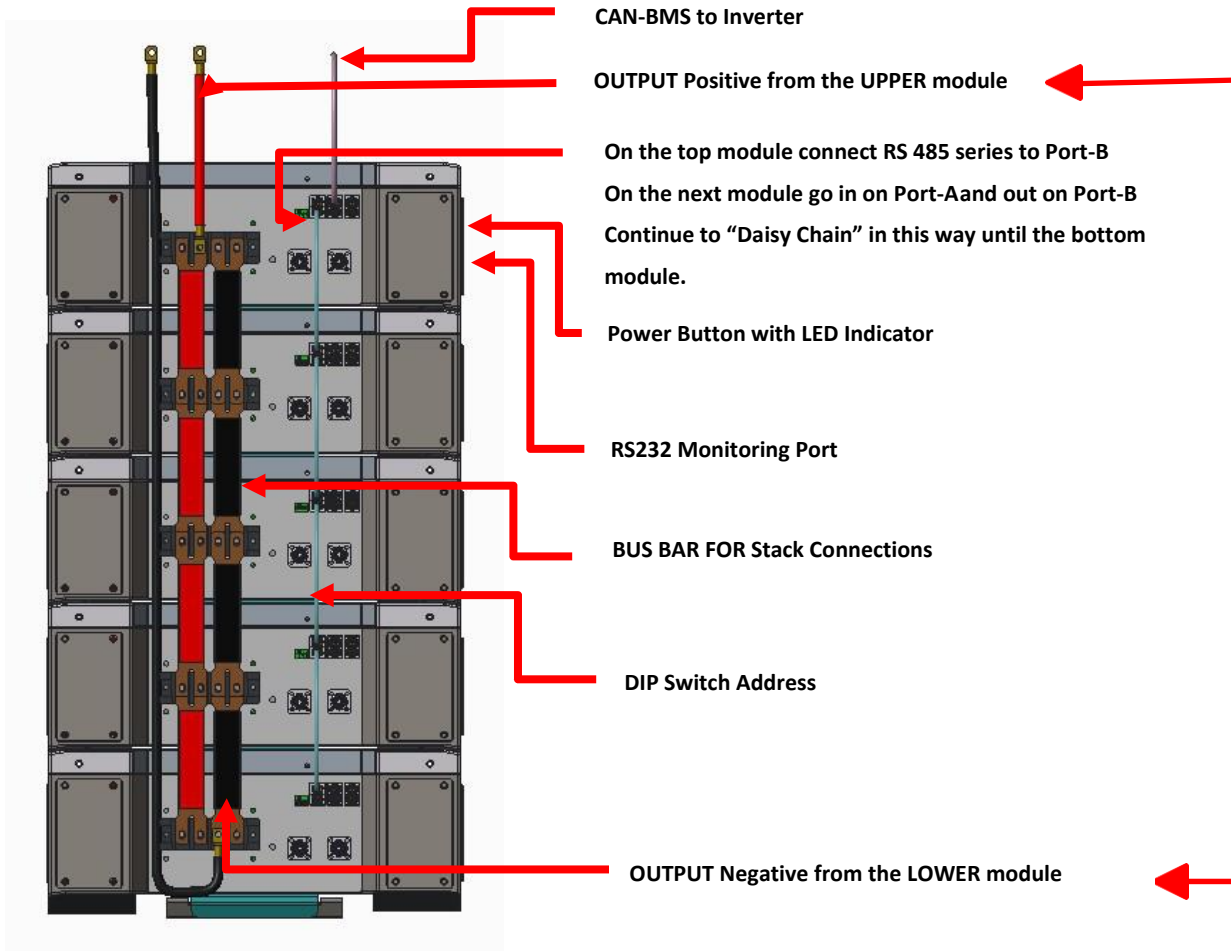

Information: When multiple battery boxes are connected together is possible to choose between "capacity" chain series or parallel to increase capacity and peak. In case of parallel the parallel battery and inverter can only communicate through CAN interface, and the communication between the batteries will be through RS485



Attention: Be sure to follow the above method of "daisy chaining" the RS 485 connections, starting at Port-B on the upper battery module then into Port-A on the next module and out of Port-B then into Port-B on the next module, and so on.



Caution: B+ interface is always positive, B- interface is always negative; GND is for the parallel battery grounding port.



Information: Arrange the cables according to the particular installation requirements, always paying attention to minimize the length of the cables to avoid voltage drops.

Attention: On the top battery module keep the original connection HUB cover

1st



8th or Last

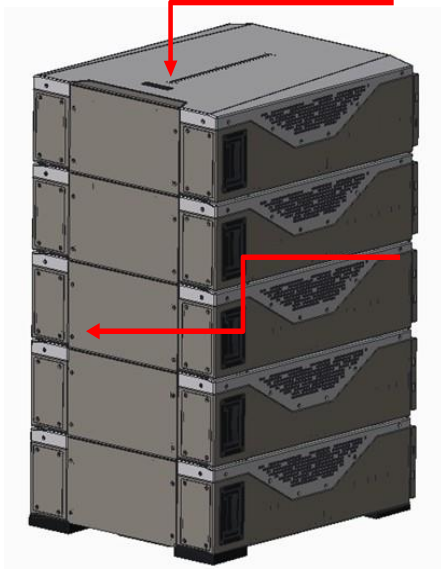

Attention: Install the stackable flat front cover plate to protect the bus bar and cables **BEFORE TURNING ON**

Battery installed correctly, see image below.

1st



8th or Last

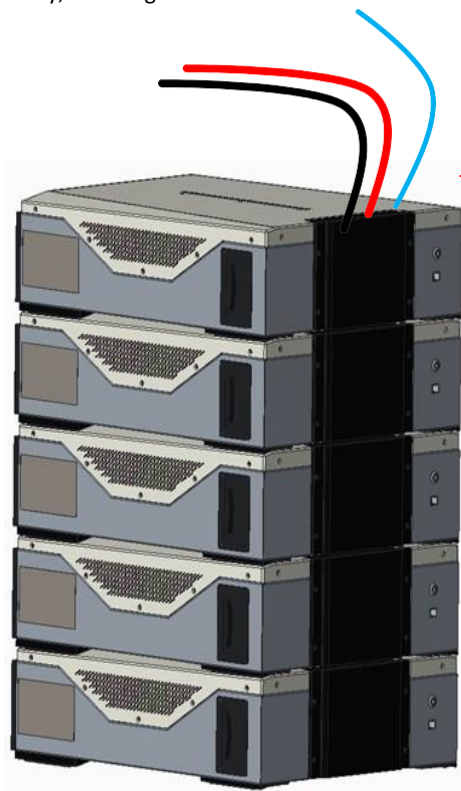

Suggested Cable Output from the Upper Side.

2.5 Module Activation and Shutdown

2.5.1 LED Visual Indication Lights

There are two sources of visual indications on the battery module.

- Power Button
- LED Bar

There follows an explanation for the indications made by each of them.

2.5.1.1 Power Button

The Power Button is located to the right of the battery terminal connections on the side of the battery. The Power Button is a multi-color button and will provide the user with the following indications depending on the state of the battery

Name	Meaning	Function or indication status
POWER BUTTON	On/Off Button	Switches the Battery Module on and off.
RUN	Running indicator light (GREEN)	When the battery box is running Normally, it always bright.
LOW BATTERY	Low battery indicator (YELLOW)	When the battery is low (SOC<0-10%), it is always bright.
FAULT	Fault indicator light (RED)	When there is a fault with the battery module it will flash RED



A 2-second press on the Power Button will turn the battery module on.

A 5-second press on the Power Button will turn the battery off

Other functions of the Power Button are explained in the relevant sections of this manual.



Attention: Read this entire manual thoroughly to understand the correct start up and shut down procedures for each battery configuration.





Attention: Illustrations shown are for reference only, please always refer to the physical battery module in front of you and if the module has a different configuration to this manual, stop all activity immediately and contact WeCo support on service@weco.uk.com.

2.5.1.2 LED Bar Indications

The LED bar is located on the front of the battery and is purely a visual indication.

Start up



1. LED bar check, all the Blue LED will blink
2. SOC green LED will appear to the actual statuses of SOC

Warning indicator (Most of the time switched off)
 SOC 81-100%
 SOC 31-80%
 SOC 6-30%
 SOC < 5%

Over/Under Temperature Fault



1. If the temperature rise above the BMS limits the contactor open
2. The LED bar will start blinking in red color

Warning indicator
 SOC 81-100%
 SOC 31-80%
 SOC 6-30%
 SOC < 5%

Firmware upgrade



1. During the firmware upgrade the first blue LED will blink for the entire duration of the upgrade process
2. After the contactor open/close the LED bar turn to normal status.

Warning indicator
 SOC 81-100%
 SOC 31-80%
 SOC 6-30%
 SOC < 5%

SOC Mismatching



Warning indicator
 SOC 81-100%
 SOC 31-80%
 SOC 6-30%
 SOC < 5%

Major Fault



1. Wrong voltage current reading or any abnormal reading
2. All of the LED bar will remain fixed red color
3. The warning indicator will blink in red color every 0.5 SEC
4. The SOC indicator will show the actual status of charge

Over Current



1. If the current exceed the BMS limit
2. Full LED bar blink in red color

Warning indicator
 SOC 81-100%
 SOC 31-80%
 SOC 6-30%
 SOC < 5%



2.5.2 Stand Alone Battery Front Panel Control

2.5.2.1 Start Battery

Short press the power button for one second. The GREEN RUN light should come on. The battery has been activated normally.

2.5.2.2 Shut Down Battery

Long press the power button for five seconds. The GREEN RUN light should go off. The battery has been shut down normally.

2.5.2.3 Low Battery – Force Charge

Prerequisite: The **VOLTAGE** between the battery B + and B- terminals is **ZERO** and the **PANEL LIGHTS ARE OFF**. Battery is in “Shutdown State”.

Preparation condition before forced charging: Connect the charger or the inverter with charging capability to the B+ and B- of the battery box to ensure charging capacity.

Forced charging approach: Short press the battery power button, the battery RUN light will flash green, which means that the battery is entering the compulsory charging mode. If the battery receives an adequate charging power (above 10 Amps/58V) within 90 seconds from pressing the button, the battery will continue to charge normally until a stable state is reached.

If the battery does not receive adequate charging power within 90 seconds after pressing the button, the battery will enter the shutdown mode once again.

During the forced charging period the low battery LED will be steady orange up to an SOC of 10% at which point the low battery LED will go out.

2.5.3 Parallel Battery Configuration

1. The voltage difference between any of the batteries in the stack must not be greater than 2V. Otherwise, the BMS will not allow the batteries to be activated in a parallel connection.
2. SOC of each battery in the stack must be the same (check SOC as individual battery before parallel connection)
3. The power cabling between the batteries is in accordance with section 5.6 of this manual.
4. All DIP switches are configured in accordance with section 5.5 of this manual.
5. The RS 485 inter battery data connections are properly connected as per section 5.6 of this manual. The data connection “daisy chain” must start from port-B of the master battery (do not install the RS485 on the port-A of the master battery, it will occur in a fault)
6. Connect the CAN port of the master battery with the CAN port of the inverter and make sure that the communication is working properly by checking the inverter display
7. Before activating the system, the operator should check the cable connection carefully and make sure that all safety procedures are respected. Check the inverter settings and connection before turning on. In case of an inverter without communication make sure to set the voltage and current value as per the charge/discharge parameters provided in this manual.



2.5.3.1 Activation of Parallel Batteries (From Master to Slave#4)

Short press the Master power button for one second. The GREEN RUN light should come on. The battery has been activated normally.

Short press the Each Slave power button for one second. The GREEN RUN light should come on. The battery has been activated normally.

2.5.3.2 Shutdown of Parallel Batteries

Long press the Master Power button for five seconds. The GREEN RUN light should go off immediately.

The GREEN RUN lights on the slave batteries will not be extinguished immediately.

The RED FAULT lights on the slave batteries will start flashing after ten seconds and the GREEN RUN lights will remain on.

After one minute the RED Fault lights and the GREEN RUN lights on all slave batteries will go off.

The parallel battery system has shutdown properly.



NOTICE:

In a parallel battery system, we strongly advise not to switch off individual slave batteries. If there is a reason to switch off a slave battery, we recommend that the procedure described in 6.3.2 of this manual is followed.

Switching off an individual slave battery in a parallel system is possible in an adverse situation, but only as a last resort.

2.6 LV Product Compatibility List + Maximum Modules Permitted per Cluster

2.6.1 Direct Parallel with CAN Communication

LOW VOLTAGE COMPATIBILITY							WeHUB		SUPER HUB		
Battery model	Capacity kWh	Inverter Brand		Inverter Series	Battery CAN Selection	Battery Direct Parallelability N*	Battery Bank Capacity (kWh)	WEHUB battery parallelability N*	WEHUB battery Bank Capacity kWh	SUPERHUB battery parallelability N*	SUPERHUB battery Bank Capacity (kWh)
5k3 LV-HV	5.2		Azzuro ZCS	HYD	WeCo CAN	8	41.6	40	208	100	520
			Deye	All	CAN00						
			Schneider	XWPRO	Schneider CAN						
			Schneider	XW +	Open Loop						
			Phocos	PSW Anygrid	Voltronic CAN						
			Growatt	SPH							
			SMA	Sunny Island	SMA CAN						
			Solis	All	Solis CAN						
			Goodwe	EM	Goodwe CAN						
			Studer	Extender	Studer CAN						
			Sofar Solar	HYD / SP	WeCo CAN						
			Victron Energy *	via Color Control	Victron CAN						
			TBB energy	All	CAN00						
			IMEON	All	SMA CAN						
			INVT	All	INVT CAN						
			Voltronic	All	OLP CAN						
			MorningStar	48V types	Open Loop						
			Kehua Tech	All	Kehua CAN						
			Must Solar	All	OLP CAN						
			LuxPower	All	WeCo CAN						
	Solax	LV series	Solax CAN								
	Sungrow	Hybrid Series	WeCo CAN								
	Steka	All	Open Loop								
	Outback	All	Open Loop								
	TSUN	All	WeCo CAN								
	MPP solar	All	Voltronic CAN								

*-Protocols developed by WeCo



2.6.2 LV Direct Parallel Without BMS Communication with Inverter

In general is not suggested to use the batteries without communications with the inverter, however in exceptional cases of back up application it is possible to set the inverter without CAN/BMS communication according with the below chart.

Description	Inverter Low Voltage CUT OFF	Inverter High Voltage CUT OFF	STD Charging Current (max 120A)	STD Discharging current (Max 200A 2sec)
Single Battery	50.5 =SOC 0% Suggested 51,3 =SOC 10% if OFF GRID	55,4 Suggested 54,5 =Absortion 10A	100A	100A
Master + Slave1				
More than 2 batteries not it is mandatory to use a CAN/BMS communication Approved inverter				
TEMPERATURE/ C-RATE				
	1C + Overload		0.5C	
CHARGE	-8°C +55°C		-9°C – 15°C	
DISCHARGE	-20°C +55°C		+56°C +65°C	
CHARGING CURVE SET	Charge 0% to 90% Discharge 100% 90%		Charge 90%-100% Discharge 10%-0%	
CHARGING	-100A		-20A	
DISCHARGING	100A		20A	



2.7 Overview of Multi Cluster System

-Double BUS BAR-

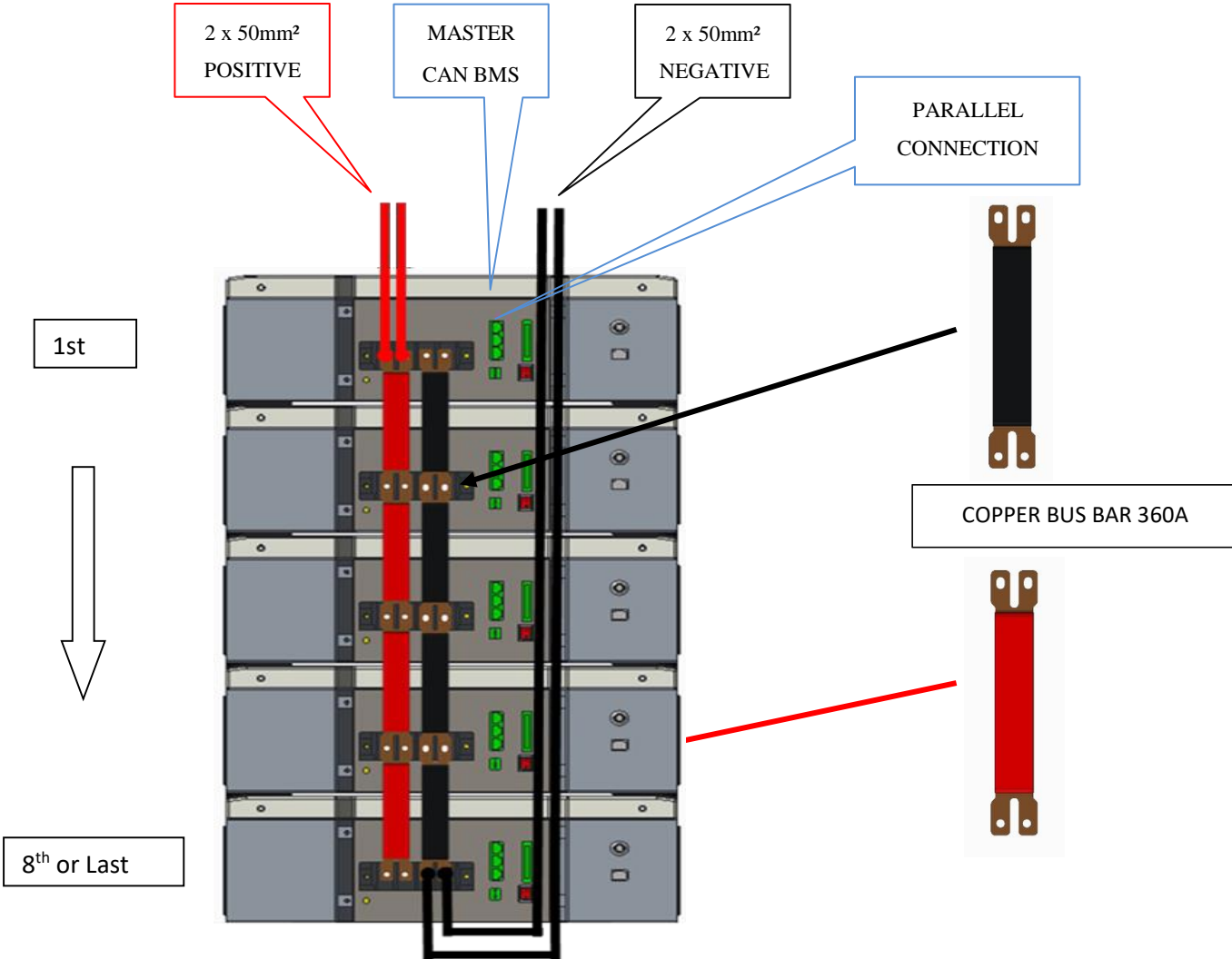

40 Nm Parallel Screw Terminal must be checked every 3 months

2.8 CAN Hub for Multi Cluster Configuration

REQUIRED IF MORE THAN 1 CLUSTER



BMU BMS COMBINER We-HUB LOW VOLTAGE



SEE THE POWER/CURRENT CONFIGURATION BELOW

Each battery pack and each cluster must have the same soc %

Above 120a must use the bus bar provided by WeCo (**order ref. -stk 5k3-300**)

Each cluster must have the same number of battery packs



This BMS BMU Master Hub is mandatory when more than one cluster is connected on a common bus bar.



The Master HUB works only with CAN communication approved inverters.

**WeHUB can manage a maximum of 5 clusters composed by a maximum of 5 modules each
TO BE USED WITH BUS BAR CONNECTION ONLY**

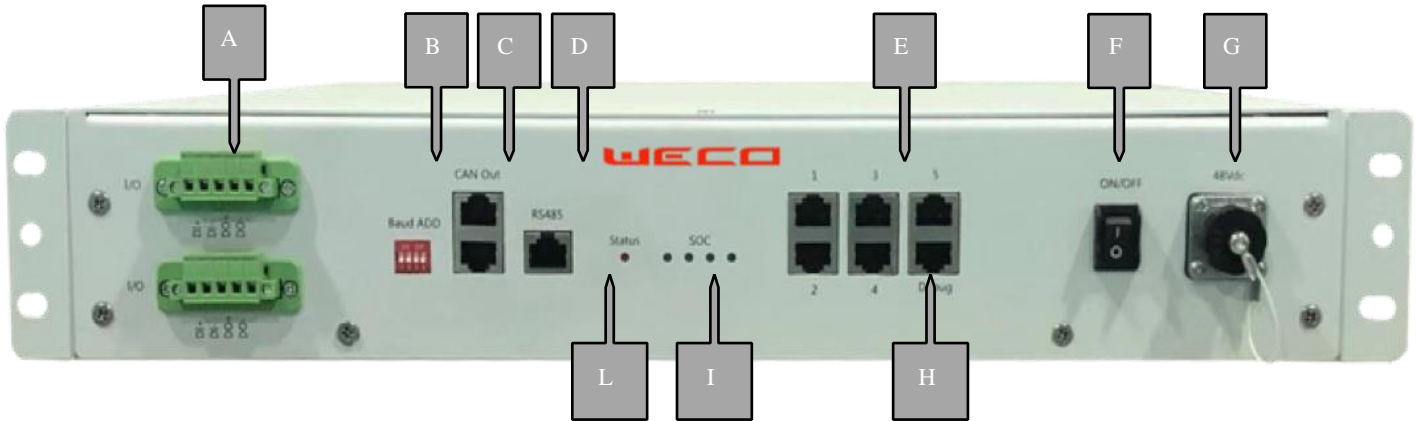

Interface description and connector		
A	I/O CONTACT 2X	Programmable closure/ contact
B	DIP SWITCH	Baud Rate Selection
C	CAN BUS PORTS 2X	CAN Bus port for external solar – grid charger
D	RS 485 port	RS 485 communication port (MODBUS)
E	CLUSTER CAN PORTS 5X	Master Cluster CAN port
F	ON OFF SWITCH	Internal Power supply switch
G	INLET 48Vdc	Connector for power input to connect to the bus bar (1A fuse
H	RS232 PORT	External Port for programming and Debug
I	LED LIGHTS 4X	25% SOC status each LED
L	POWER INDICATOR	Power Supply LED Status





2.8.1 CAN Hub Dimensions

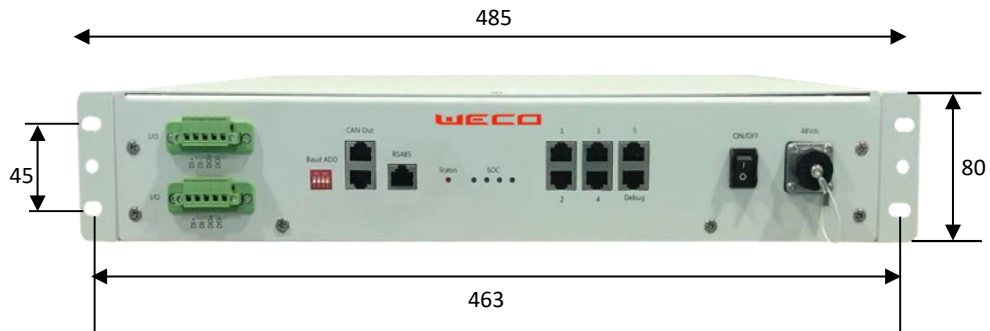

Weight: 8kg

2.8.2 Control Logic and Protection Limit

The inverter, if has the functions must be set with the below restrictions in addition to the BMS control logic

MAX CURRENT WITH BUS BAR

CURRENT SETTING / BMS CURRENT LIMIT					
Clusters \ Batteries	1	2	3	4	5
1	---	189	252	336	420
2	189	340	454	605	680
3	252	454	544	645	800
4	294	529	664	753	800
5	367.5	595	800	850	800
6	430	640	850	900	950
7	500	710	900	900	1000
8	570	800	900	900	1100
INVERTER LIMITS CURRENT: as per this chart	HIGH VOLTAGE 56,5 Vdc LOW VOLTAGE 50,5 Vdc				



1. The charge current will be limited to 0A when the single module voltage has been reached 56.8V.
2. The discharge current will be limited to 0A when the single module voltage has been discharged to 50.4V.
3. The battery system will communicate with the inverter to limit the current.
4. Each battery will be protected by the same logic separately as per single module protection concept.
5. If some modules, individually will reach any fault status the single module will protect and disconnect from the system in less than 3 seconds.
6. The current limit must be adjusted according to the real active batteries in system in order to restore the normal function.
7. If the cluster is not balanced, the current limitation set from the HUB to the inverter will be sent in order to manage the rest of active modules and clusters, in the same time the imbalanced modules or cluster will equalize in standby mode and will reconnect once in the normal range.
8. If there is more than 2 batteries in one cluster are in protection mode, the entire cluster will protect by shutting down.
9. If there is more than 2 cluster in protection mode, the full system will protect.
10. The battery sends information to the inverter to limit the charge/discharge current to zero Amps if the battery is detecting an over current.
11. Current limit protection cycle allows an automatic reconnection for three times, above that is necessary a manual restart check, a prior a full system control is mandatory.
12. If the current of one cluster is larger than the current limit, the battery system send a warning according with the single module BMS logic
13. If the warning does not recover in 5 minutes, the cluster will shut down and a manual reconnection is required prior a full system control.



2.8.3 CAN Hub General System Description

2.8.3.1 CAN Hub is Mandatory for Multiple Cluster Installation



MASTER CAN of EACH CLUSTER

NEGATIVE BUS BAR

2 x 50mm² POSITIVE

2 x 50mm² POSITIVE

2 x 50mm² NEGATIVE

POSITIVE BUS BAR

2 x 50mm² NEGATIVE

1st

1st

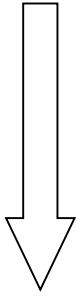
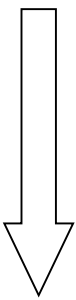

8th or Last

8th or Last



2.8.3.2 Special BUS Bar for Parallel Configuration

(BUS BAR MODEL -STK 5K3-360)

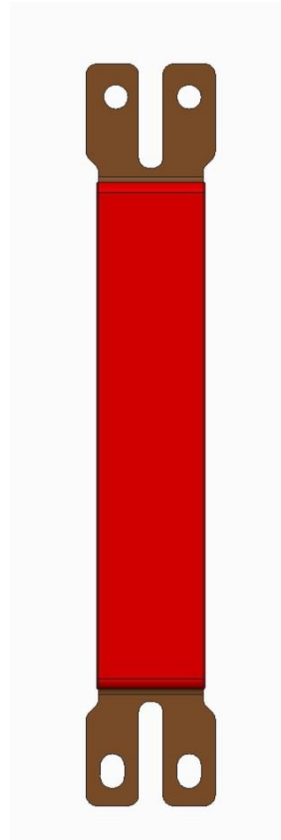
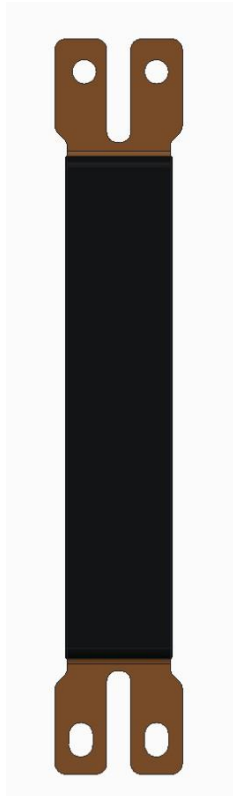

 **ATTENTION: BUS BAR ARE MANDATORY FOR STACK SYSTEM**

 **ATTENTION: DO NOT USE DIFFERENT BUS BAR TYPES OR CABLES**

 **ATTENTION: EACH BATTERY AND EACH CLUSTER MUST HAVE THE SAME SOC% and VOLTAGE
ALL THE BATTERY MODULES MUST HAVE THE SAME FIRMWARE**

2.8.4 Multi Cluster Configurations

1. Before Using the MASTER HUB device make sure to update the battery Firmware with the specific version for CLUSTER APPLICATION
2. To use and set up the MASTER HUB the installer must read the MASTER HUB MANUAL available in the Download Area of WeCo's Web Site www.wecobatteries.com
- 3.
4. Install the Specific FW on each battery * the Cluster Connection FW has a nomenclature starting with 4.xx (see website)
5. Set the Cluster ID using the WeCo monitor Cluster Software
6. Connect the HUB (pre-configured by WeCo at the Order) in case the installers needs to change the Number of modules per cluster or change the MASTER HUB communication Protocol it will be necessary to use the CAN ANALYST WECO II to set up the new configuration

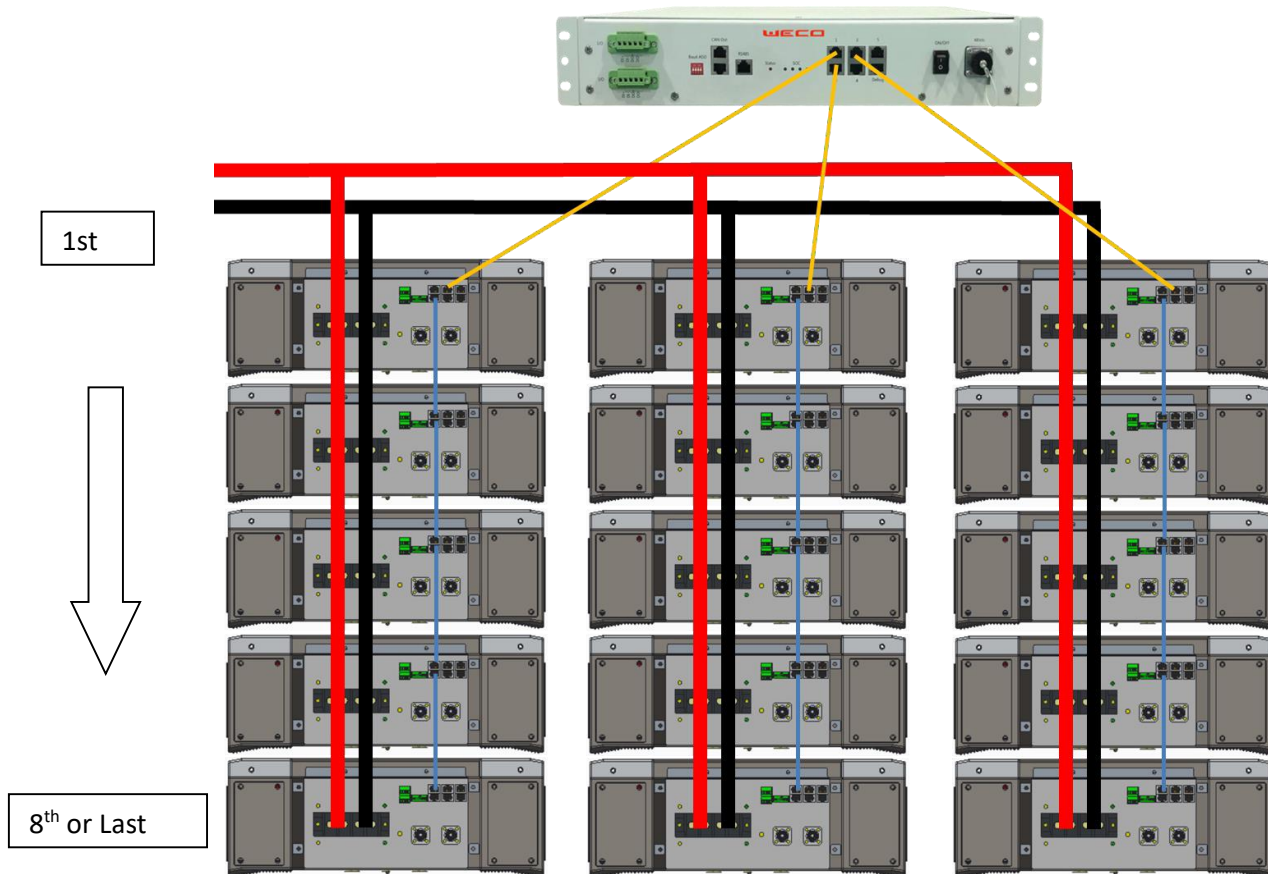

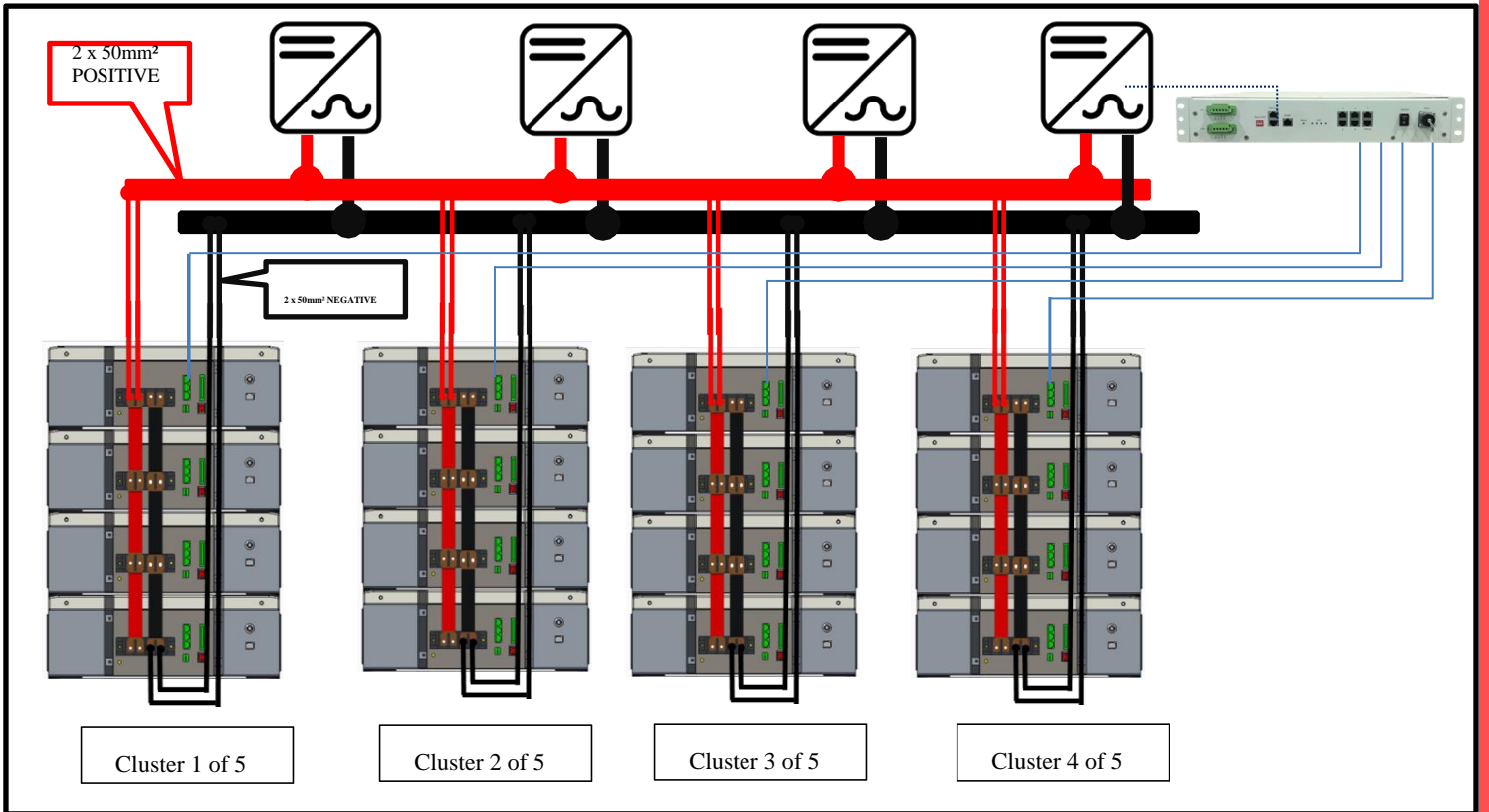
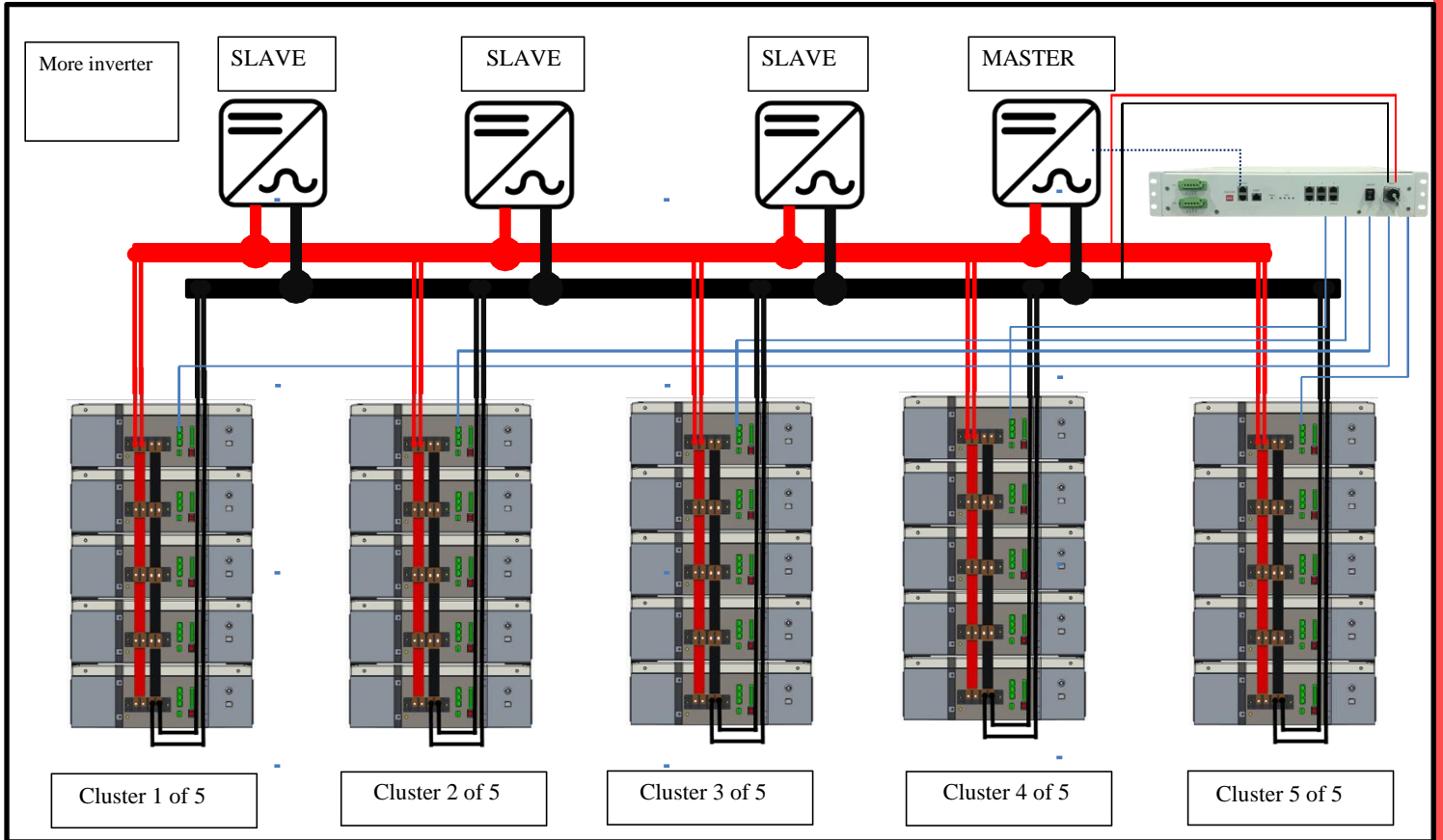

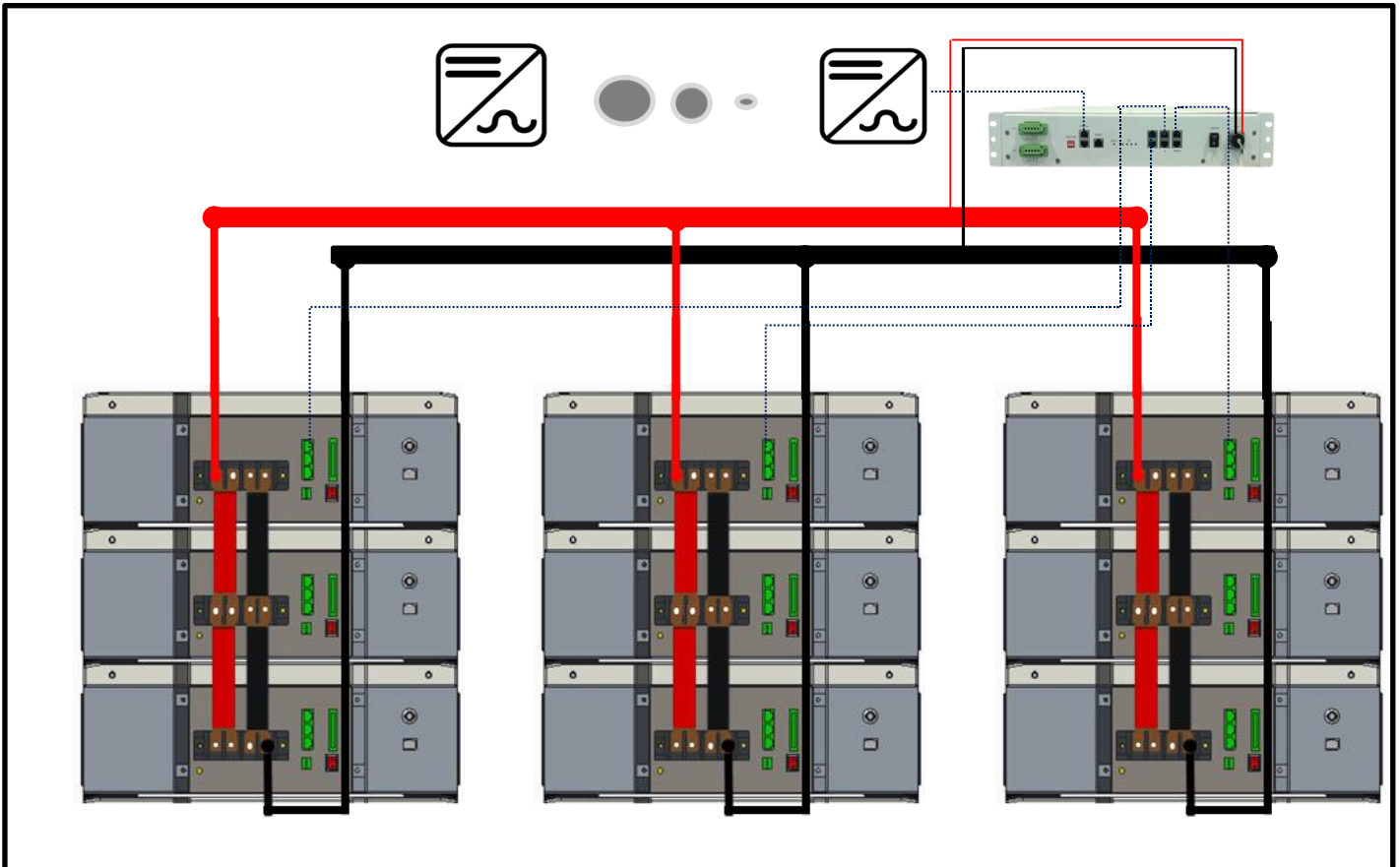
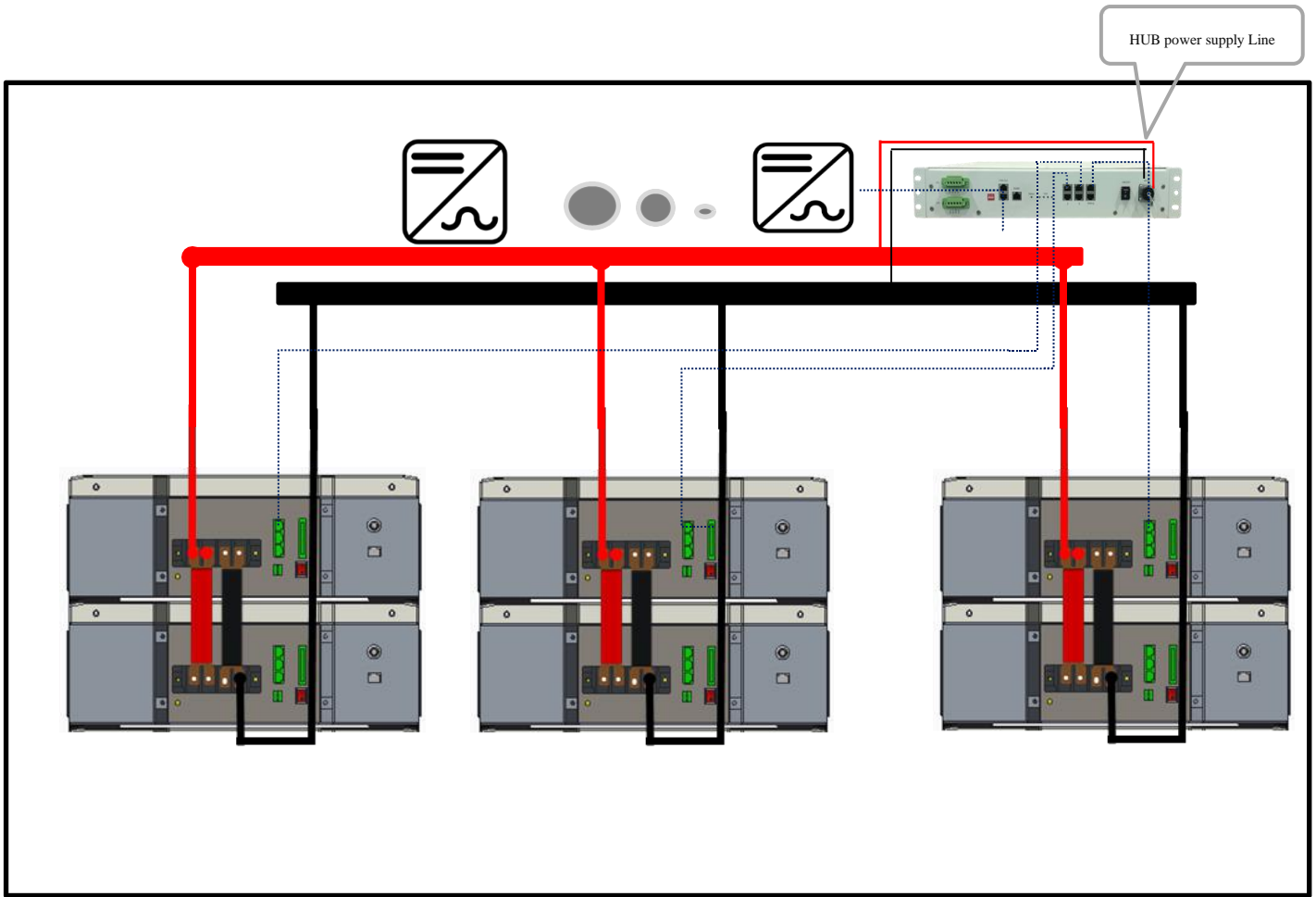

2.8.5 Cluster Configuration Accessories

2.8.5.1 360A Single Cluster Configuration Kit

KIT ORDER CODE-STK 5K3-360

STANDARD KIT (Order Ref. -STK 5K3-360-)		
<p>1 x Custom BUS BAR Insulated RED module connection</p> <p>1 x Custom BUS BAR Insulated BLACK module connection</p>		<p>Packed in single box</p>

Not included with standard kit

2.8.5.2 Multi Cluster Hub Device

KIT ORDER CODE MASTER HUB 300 LV-5

HIGH CURRENT KIT (MASTER HUB 300 LV-5) Accessory to ordered separately		
<p>1 x WeHUB parallel Controller</p>		<p>Packed in carton box</p>
<p>1 x WeHUB cable power supply</p>		



2.8.6 Inverters with no Communication Facility

Some inverters have no communication ports or protocol to communicate with the LV/HV 5k3 battery.

In this situation great care must be taken to adhere carefully to the following settings for a single cluster design.

LV/HV 5K3	Individual Module Setting	
Nominal DC Voltages	51.2	
Amp Hours	102	
Rated kWh Capacity	5.3 kWh	
Max Output Capacity	102 Ah	
Standard Charge Current	100 Adc	
Max Charge Current	120 Adc Peak	
Standard discharging Current	100 Adc	
Max discharging Current	200 Adc Peak 2sec	
DC Voltage (extreme)	46.5	58.7
Depth of Discharge	Up to 100% (suggested 95%)	
Operating Efficiency	98%	
Operating Temp	-25° to 65°C	
Charging Temp	-10° to 55°C	
Self-Discharge Rate	<1% self-discharge per month	
Memory Effect	None	
Warranty Period	10 Years	
Dimensions	51x55x15 cm	
Weight	52 kg	



SECTION-3 HIGH VOLTAGE CONFIGURATION

SERIAL CONNECTION AND SYSTEM CONFIGURATION

HIGH VOLTAGE STACKABLE CONFIGURATION



ATTENTION

**THIS SECTION IS FOR HIGH VOLTAGE CONFIGURATION ONLY
IT IS COMPULSORY TO USE THE HV BOX FOR THIS CONFIGURATION**

SECTION-3 HIGH VOLTAGE CONFIGURATION

3.1 Product Introduction

The 5K3 LV-HV modules can be used as an on-grid or off-grid energy storage system. It is not recommended to use this product for any purpose other than the intended purpose as described in this document.

Use of this product other than as described in this document will nullify the product guarantee. The substitution or installation of any components of this battery will nullify the product guarantee.

The use of any components contained within or connected to this battery other than the products sold as part of this product or recommended by the manufacturer will nullify the product guarantee.



ATTENTION: do not exceed the number of 6 modules each tower



ATTENTION: The maximum number of batteries that can be connected in series is 12



ATTENTION: The HV BOX is a compulsory protection and communication device that must be installed for any High Voltage Configuration



ATTENTION: Attempting to operate the batteries with less than four batteries in series or more than 12 batteries in series will nullify the product guarantee.

Module Weight 52Kg

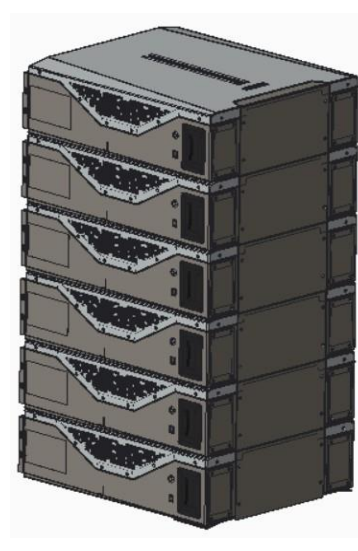
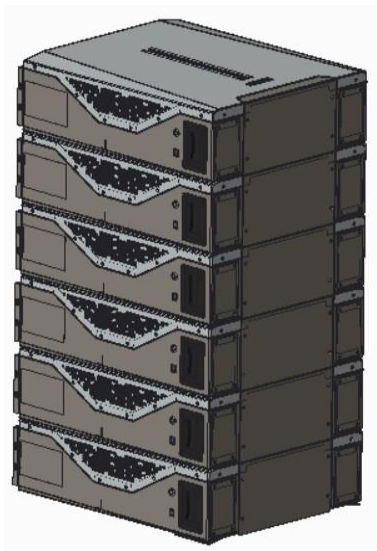

ATTENTION

A cluster of 12 modules weight 624Kg, the support structure/floor must be properly inspected before start the installation of the modules.

3.1.1 Identifying the Individual Module

Dimensions	mm	510x550x150
Weight	kg	52
Case material	Type	Steel
Parallel Units	N°	5
Stackable	Type	Yes
Digital Output	N°	2

Dimensions	mm	510x550x150
Weight	kg	52
Case material	Type	Steel
Parallel Units	N°	5
Stackable	Type	Yes
Digital Output	N°	2

Cell Type	ID	LiFePO4
Cells Distribution	P/S	16S
BMS charge Temp.	°C	-10°C +55°C
BMS Disch. Temp.	°C	-25°C +65°C
Storage Time/Temp.	°C	-20°C +45°C 4months
Self Disch Time/Temp.	%	3% month @25°C

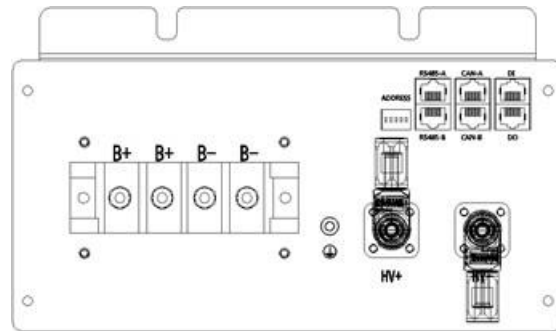

3.1.2 Product Identification and labels



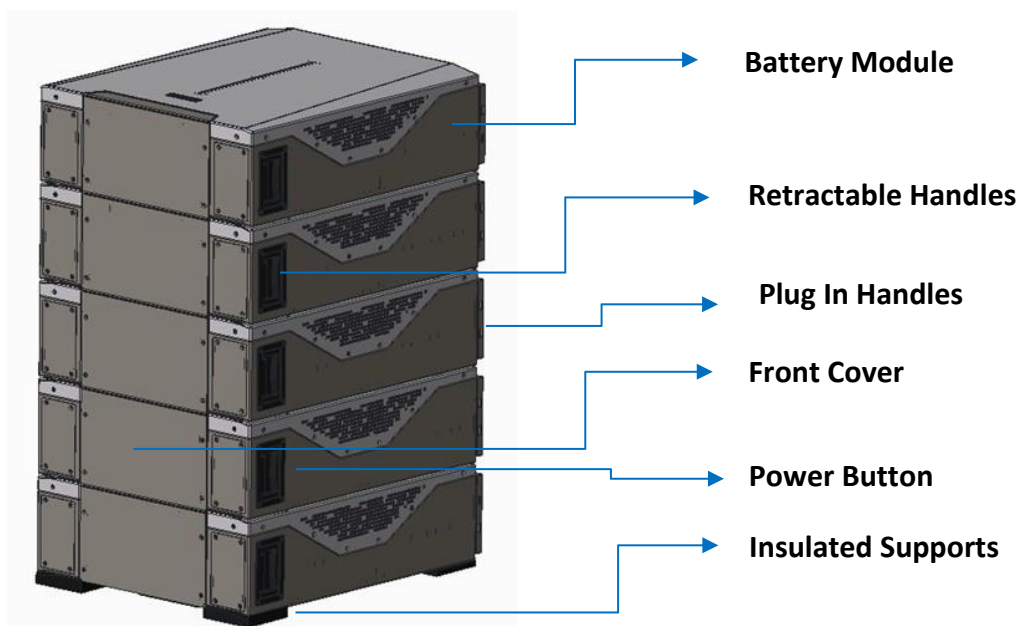

The nameplate label describes the product parameters and is attached to the product. For details, please refer to the nameplate label of the product. For safety reasons, the installer must have a thorough understanding of the contents of this manual before installing the product.











3.1.3 Accessory List (Standard Kit).

The battery is packed in a carton together with standard accessories. When unpacking the battery, be sure to check that the battery and accessories are free from damage and that the correct quantities of each component are included within the carton.

The following list of components can be used as a check list when unpacking the individual battery and battery kits.

Number	Name	Quantity	Description	Image
1	Power Cable	2	2x25mm ² AWG cable 2.5 (m) each Red/Black	
2	CAN cable RJ45 Parallel Connection	1	100cm	
3	Flat Cover	1	Flat Cover for Bus bar protection in Stackable configuration	
4	Earthing Screw	1	M5 Allen key	
5	BMS/STD	1	1 BMS std Cable 100cm	

3.1.4 Necessary Installation Tools

 Multimeter + Current clamp	 Screw Driver Set	 Allen Key Set	 Drill + Hammer
 Electrician Scissors	 Wrench set	 Lifting strap + mechanical lifter	 RS 232/USB+screw terminal (insulated)

3.1.5 Personal protective equipment



3.2 High Voltage Module Wiring and Set Up

3.2.1 Battery Connections

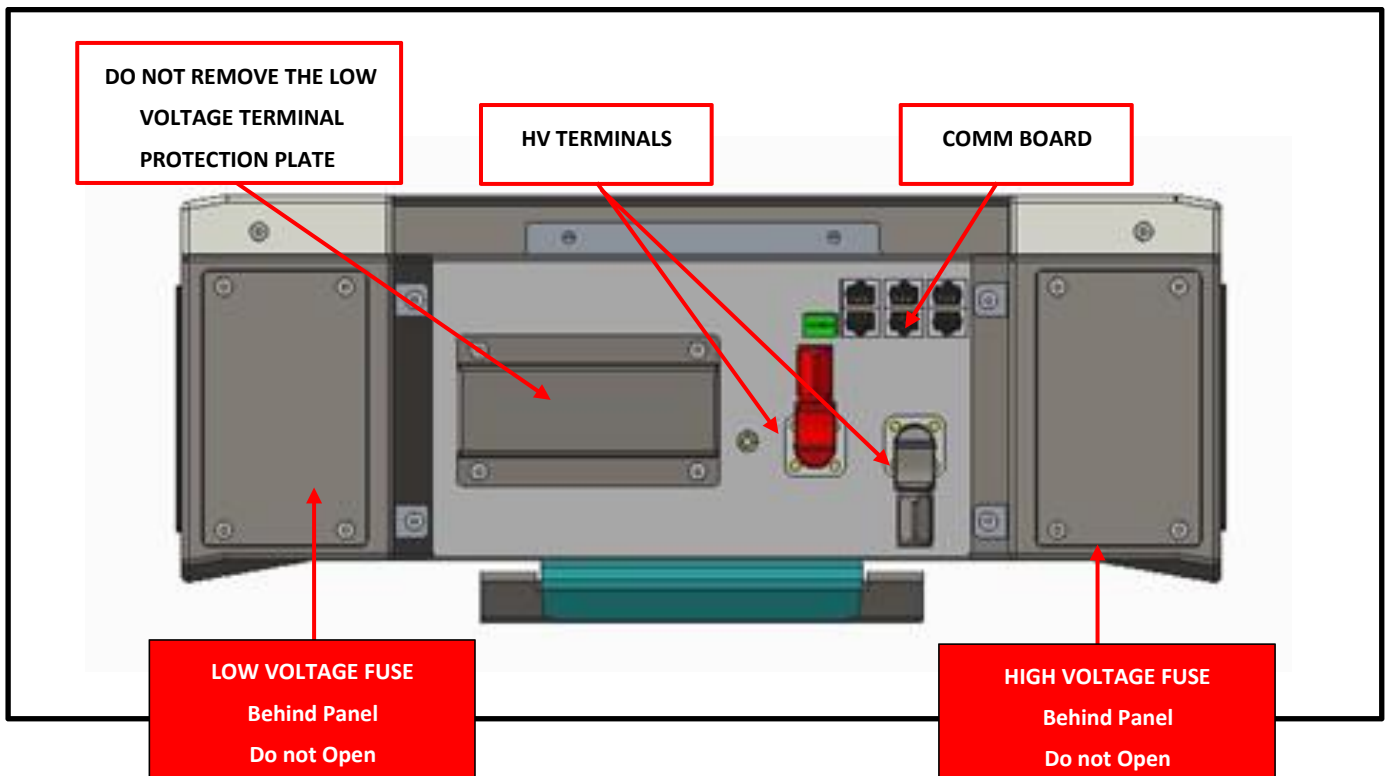
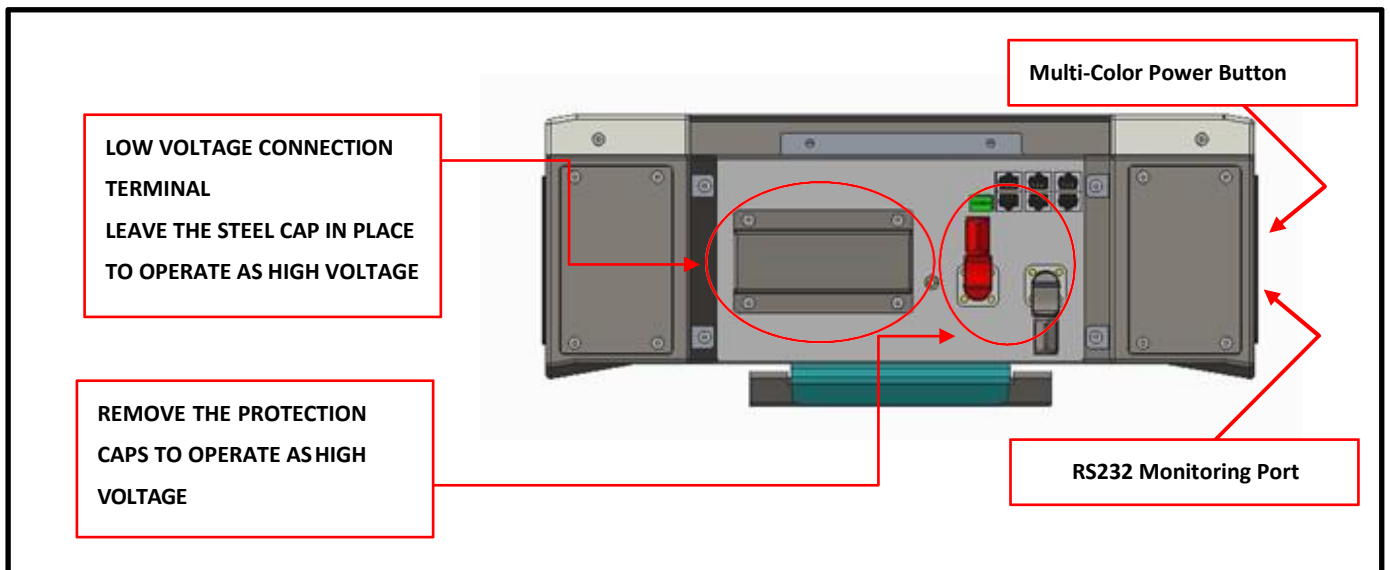

CAUTION: The LV fuse is contained in the left portion of the module as shown above.

The access to the fuse is restricted to the WeCo assistance team and the protection lid cannot be opened by anyone apart from WeCo. The same applies to the HV fuse.

3.2.2 Battery Terminal Definition

The terminal layout is shown in the following figure:

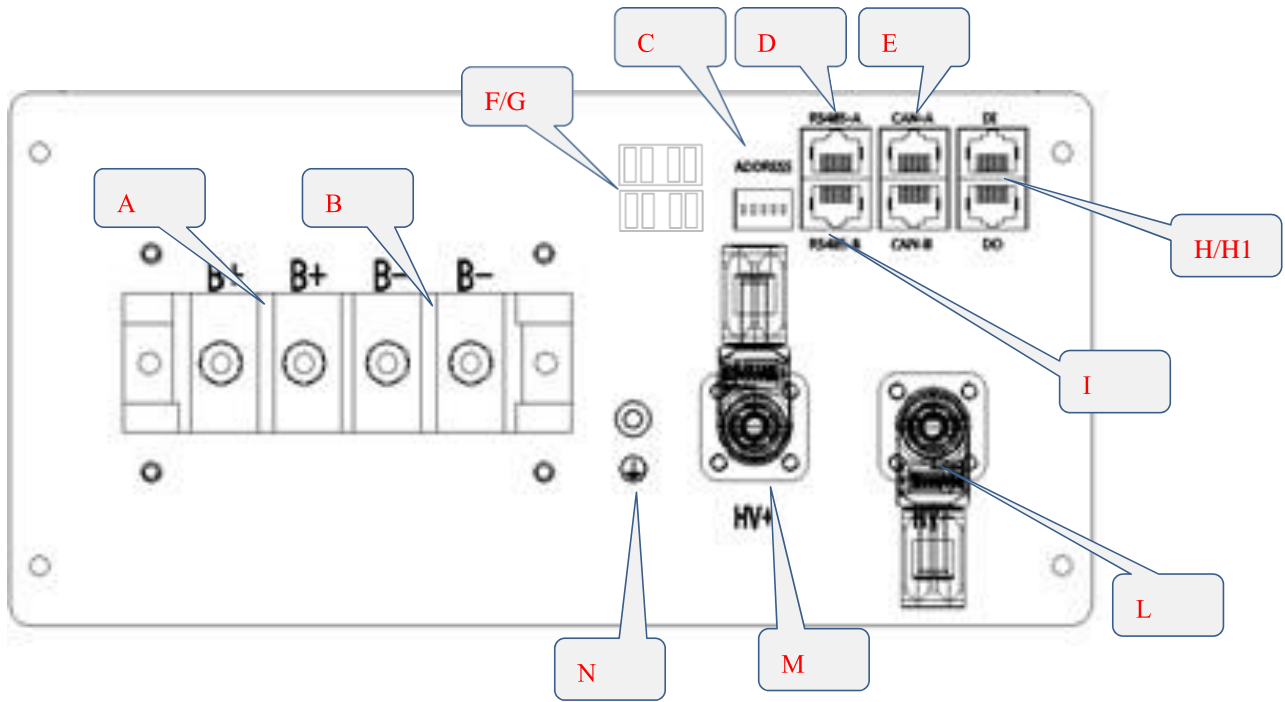

Interface	Name	Function
A	LV POLE +	LOW VOLTAGE POSITIVE (+) Screw Terminal
B	LV POLE -	LOW VOLTAGE NEGATIVE (-) Screw Terminal
C	DIP SWITCH	DIP SWITCH Address HUB (LV PARALLEL ID SET UP)
D	RS 485 A LV	LOW VOLTAGE COMMUNICATION PORT RS 485
E	CAN A	CAN – BMS to LOW VOLTAGE INVERTER
F	D/I	Digital Input
G	D/O	Digital Output
H	CAN B	LINK IN/OUT
I	RS 485 B LV	LOW VOLTAGE COMMUNICATION PORT RS485
L	HV POLE -	HIGH VOLTAGE POSITIVE (+) Fast Connector Terminal for serial connection
M	HV POLE +	HIGH VOLTAGE NEGATIVE (-) Fast connector Terminal for serial connection
N	GND	Ground terminal

Attention: Interface E: RJ45 port corresponding to the CAN bus pin definition

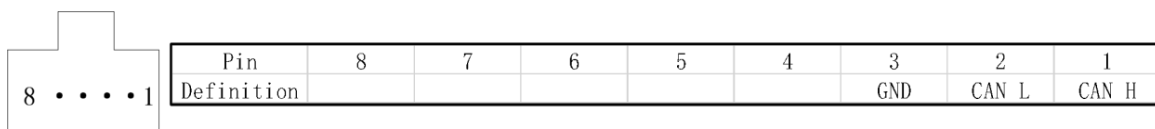

3.3 High Voltage Module Configuration – HV Box 750Vdc-



ATTENTION: The High Voltage mode mandates that the battery modules must be connected in series.



ATTENTION: The following table provides the possible module configurations NO OTHER configurations are permitted.



HV BOX 950 Vdc Type B				
Tower 01	n°	Min Vdc	Max Vdc	Capacity kWh
	1+2	Base		
Modules in series	3	150	175,2	15,6
	4	200	233,6	20,8
	5	250	292	26
	6	300	350,4	31,2
	7	350	408,8	36,4
	8	400	467,2	41,6
Tower 01	n°	Min Vdc	Max Vdc	Capacity kWh
Modules in series	9	450	525,6	46,8
	10	500	584	52
	11	550	642,4	57,2
	12	600	700,8	62,4
	13	650	759,2	67,6
	14	700	817,6	72,8
	15	750	876	78
	16	800	934,4	83,2

HV BOX 750Vdc Type A				
Tower 01	n°	Min Vdc	Max Vdc	Capacity kWh
	1+2	Base		
Modules in series	3	150	175,2	15,6
	4	200	233,6	20,8
	5	250	292	26
	6	300	350,4	31,2
	7	350	408,8	36,4
	8	400	467,2	41,6
Tower 02	n°	Min Vdc	Max Vdc	Capacity kWh
Modules in series	9	450	525,6	46,8
	10	500	584	52
	11	550	642,4	57,2
	12	600	700,8	62,4
	13	650	759,2	67,6
	14	700	817,6	72,8
	15	750	876	78
	16	800	934,4	83,2

3.4 High Voltage DIP Switch Settings



ATTENTION



ALWAYS CONFIGURE THE DIP SWITCH SETTINGS BEFORE CONNECTING ANY POWER CABLES TO THE BATTERY HV TERMINALS.



WHEN CHANGES HAVE BEEN MADE TO DIP SWITCH SETTINGS THE BATTERIES MUST ALWAYS BE RESTARTED FOR THE CHANGES TO TAKE EFFECT.



POWER CABLE CONNECTIONS MUST BE MADE IN STRICT ACCORDANCE WITH THE INSTRUCTIONS IN THIS MANUAL. INCORRECT POWER CONNECTIONS CAN DAMAGE THE BATTERY AND CAUSE INJURIES



ATTENTION: All drawings are for reference only, always refer to the physical product as the standard. If the manual does not match the physical product stop all actions, remove any connections and store the batteries in a safe place, call WeCo product assistance for support.

3.4.1 Serial Tower Connection #1 Set Up of the HV box CAN Communication Loop

Three batteries connected in series is the minimum allowed configuration for High Voltage operation:



CAUTION: After setting the DIP switches the batteries must be restarted for the DIP switch changes to take effect

Power cables Connection

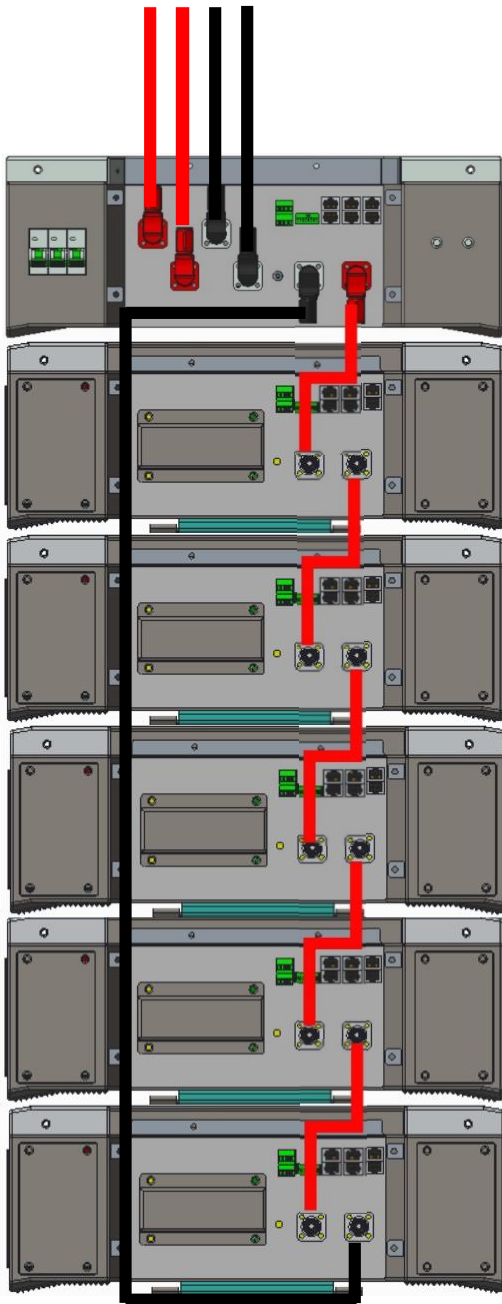

COMM cables connection

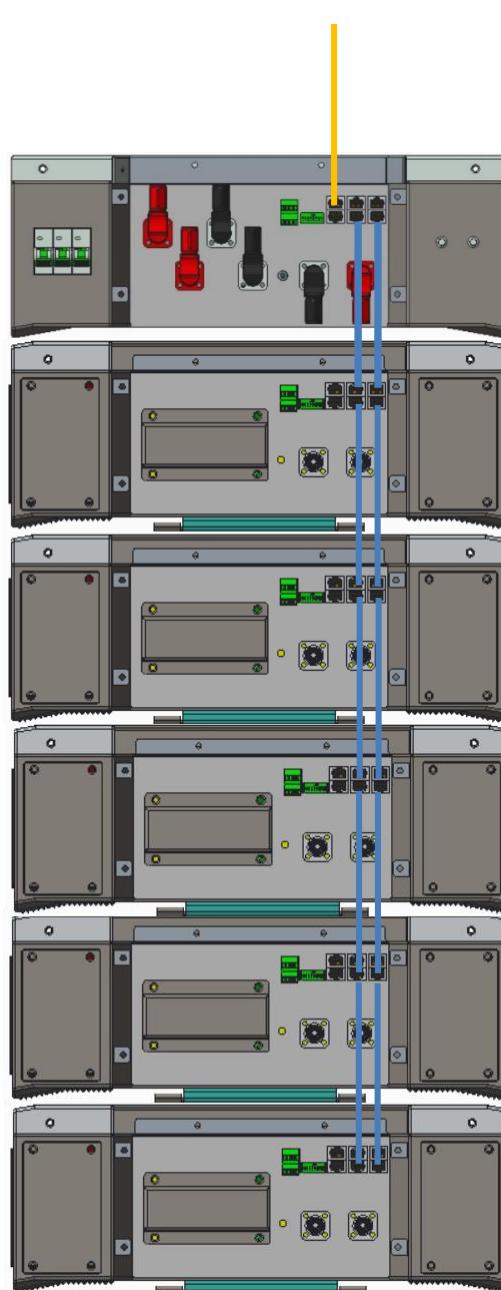

3.5 Serial Battery Wiring Connections



ATTENTION



POWER CABLE CONNECTIONS MUST BE MADE IN STRICT ACCORDANCE WITH THE INSTRUCTIONS IN THIS MANUAL. INCORRECT POWER CONNECTIONS CAN DAMAGE THE BATTERY AND CAUSE INJURIES OR SERIOUS DANGER AND DAMAGES



Attention: Screws, Cables and Bus Bar POWER CONNECTIONS must be installed with due diligence and the tightening of the connection terminal must be to 40Nm. Each terminal should be inspected and its torque checked every 3 months



Attention: All drawings are for reference only, always refer to the physical product as the standard. If the manual does not match the physical product stop all actions, remove any connections and store the batteries in a safe place, call WeCo product assistance for support



Attention: Power cable connection For High current connection diagram please refer to the specific section, charging current limitation is mandatory as per this manual instruction.



Attention: do not use power cables and data cables not provided by WeCo

3.5.1 High Voltage Power Connections (12-Modules)

- 3.5.1.1 Proceed with the physical installation of the desired quantity and configuration of the battery modules following the installation sequences and guidelines as described Section-1 of this manual.
- 3.5.1.2 Connect the power cables as indicated, making sure that the batteries are **OFF** (check the button LED on the bottom)
- 3.5.1.3 Do not connect the HB box to the inverter input cables and do not turn on the HV BOX breaker before the serial connection completion



Do Not Connect the Inverter until the HV box is completely set up



Do Not Connect the HV BOX with the inverter at this stage

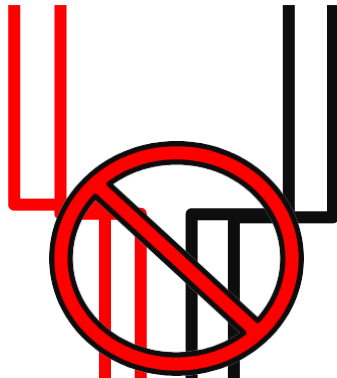

Keep The Breaker OFF

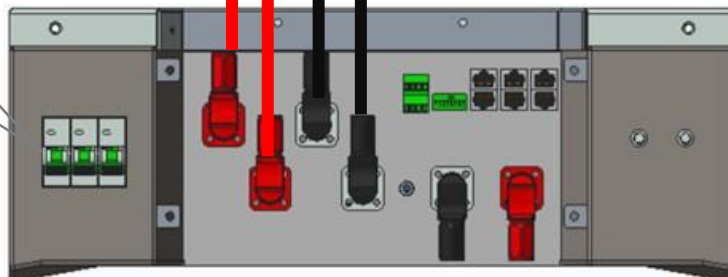

3.5.2 DATA Connections (Example of 12-Modules)

Step1: Set up the DIP Switches as per the below picture

Step 2: Connect the CAN and Link ports starting from the HV BOX port CAN A and LINK then chain connection as shown below



The HV BOX must be set up before turning it on, the DIP addresses must follow the picture below to enable the CAN communication
The last module of the series must be terminate by addressing the module as shown in the picture to ends the CAN line



HV BOX

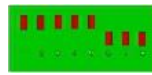

BATTERY MODULE

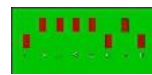

END OF SERIES



Step 4: Link all modules and the HV box with a 6mm Ground cable (In/Out) by using the GND connections point



Make sure that the ground connection is not shared with others potentials disturbing devices and that the ground rod is not used for Neutral Line dispersion or Harmonics mitigation circuit

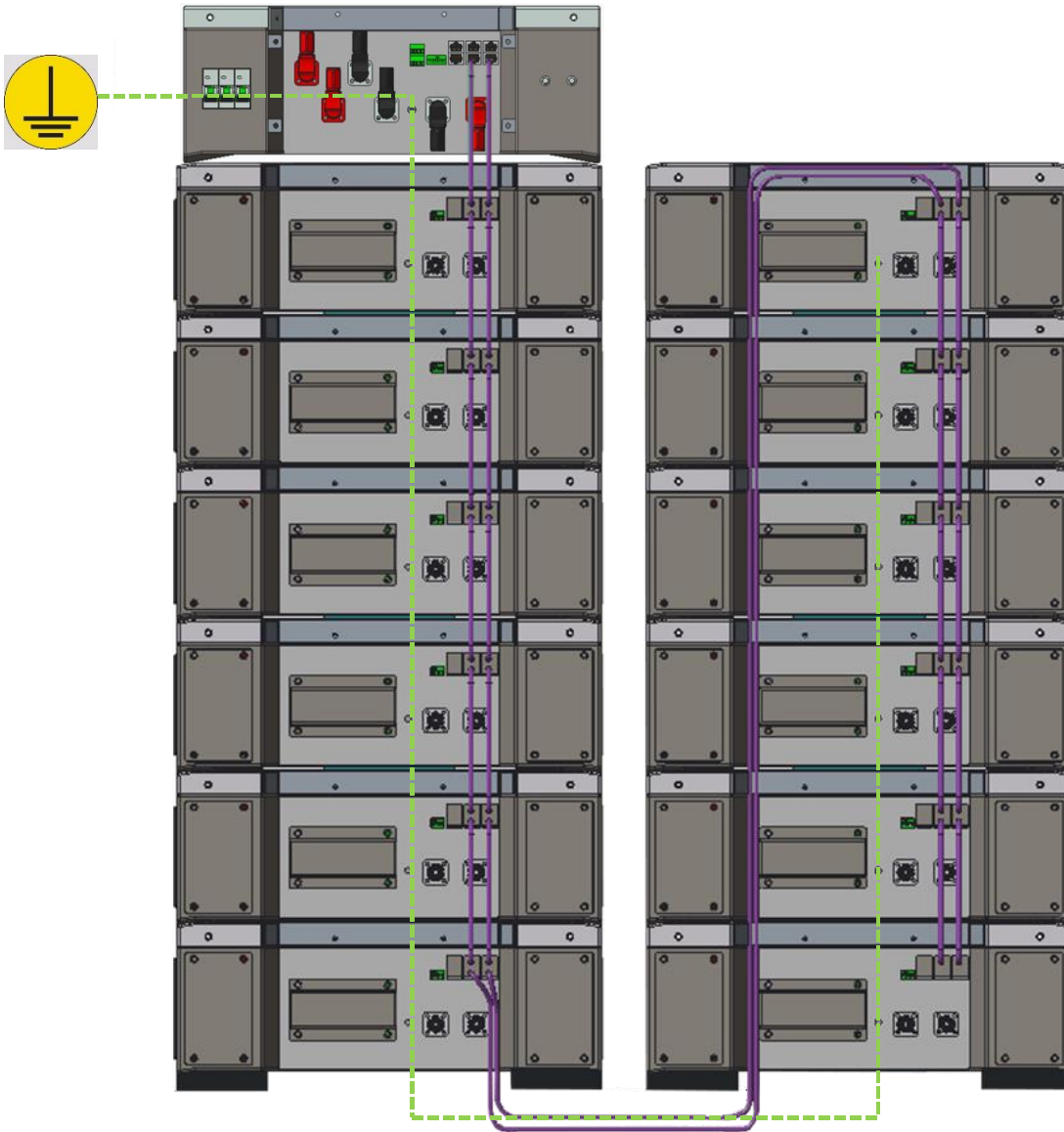

3.5.3 HV BOX AND MODULES POWER CONNECTION

Step 1: Keep the power box main breaker OFF

Step 2: connect the positive terminal of the HV BOX to the Positive terminal of the 1st battery module

Step 3: Proceed with the serial connection between all the modules

Step 4: Connect the negative output from the last module to the negative input of the HV box.

Step 5: Turn on the HV BOX breaker and wait for the start-up automatic procedure

Step 6: The HV BOX will end the startup procedure within 60 seconds by closing the input circuit

The Orange LED and the Green light will turn on by confirming the working status of the HB BOX

Step 6: Each module will turn on automatically and the side button will blink for 3 seconds then a fixed green light will confirm the run status of each module

If one or more modules will not turn on automatically means that the LINK/CAN connection between modules or the DIP address of one or more modules is not properly set up

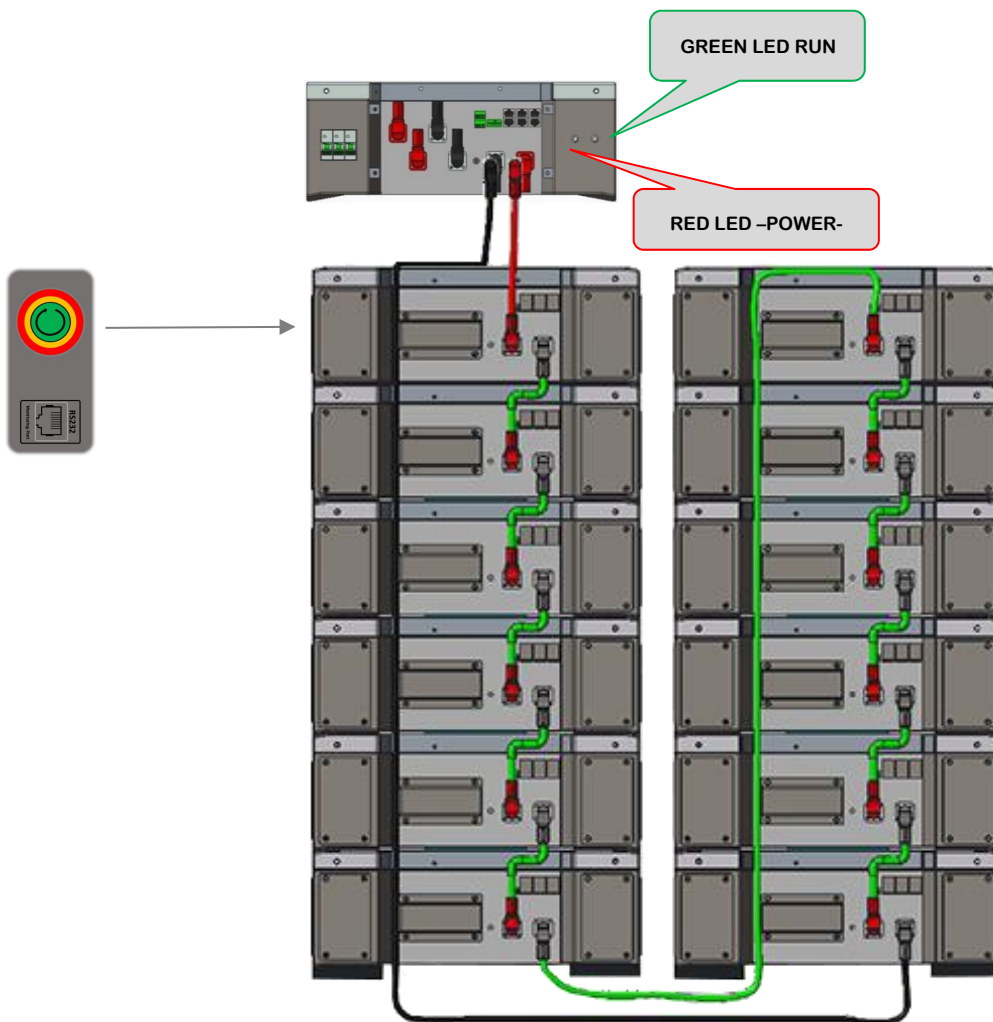

Information: Arrange the cables according to the particular installation requirements, always paying attention to minimize the length of the cables to avoid voltage drops.

Note: if the system is composed by more than 6 modules it is required to arrange the as per the image, different arrangements are strictly prohibited



Attention Azzurro CAN connection

To connect the WeCo Batteries with **ZCS Solar Inverter** (HYD 3 Ph 5-6-8-10-15-20kW) use only the CAN to Inverter cable provided with the HV BOX KIT.

When is possible, WeCo suggest to reduce the CAN cable length in order to minimize the disturbs generated by the Electromagnetic devices nearby the inverter and the batteries.

The cable provided it is crimped with a an RJ45 plug type 568B on one side while on the inverter end WeCo Provides naked terminals to facilitate the connection with the ZCA AZZURRO terminal

CAN INVERTER CONNECTION

Pin Definition.

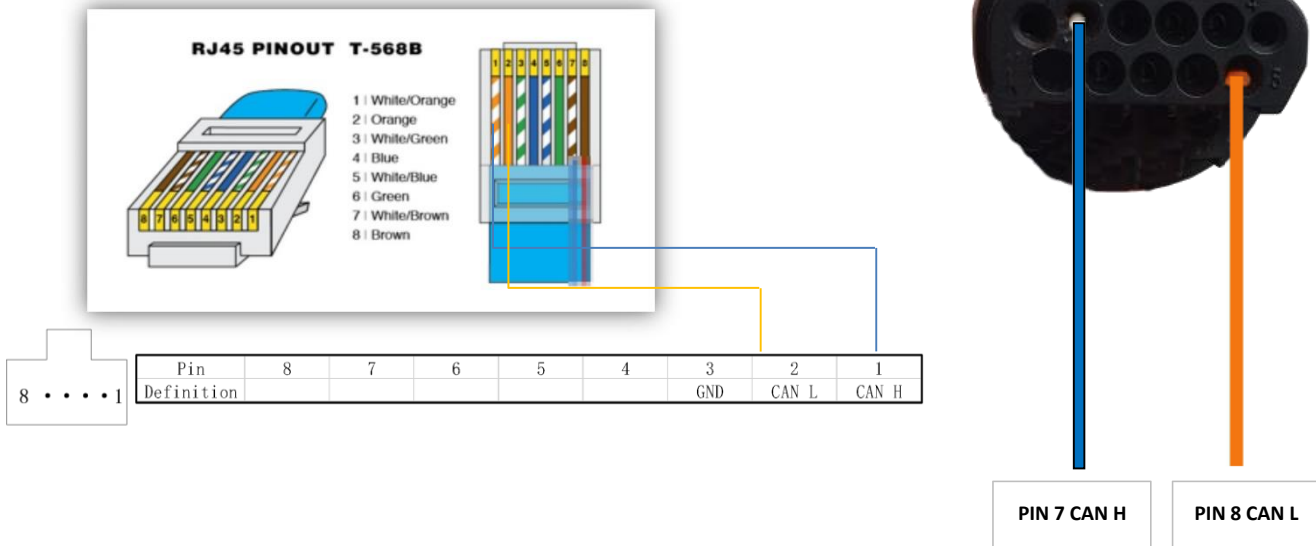

3.5.4 SINGLE HV BOX CONNECTION TO AN INVERTER

- Step 1:** Turn the HV BOX off by acting on the MAIN BREAKER
- Step 2:** Turn the Solar Inverter OFF
- Step 3:** Connect the RJ45 cable into the port CAN 2A and perform the connection as per the Inverter manual by following the PIN out provided below, make sure the CAN L and CAN H are matching the inverter terminal
- Step 4:** Connect the Power Inputs from the inverter into the H+ and H- terminals
- Step 5:** Turn on the HV BOX main breaker
- Step 6:** Wait for the startup completion of the power box (Green LED) and then turn on the Inverter



CAUTION: There are two different type of HV BOX, make sure to identify yours by inspecting the product label on the back side of the enclosure.

If your S/N is included the below list, you must follow the section set up method defined in the Section A-38



Serial Number List BATCH 38/2020

BATCH 38-2020		
HV-38-0001	HV-38-0011	HV-38-0021
HV-38-0002	HV-38-0012	HV-38-0022
HV-38-0003	HV-38-0013	HV-38-0023
HV-38-0004	HV-38-0014	HV-38-0024
HV-38-0005	HV-38-0015	HV-38-0025
HV-38-0006	HV-38-0016	HV-38-0026
HV-38-0007	HV-38-0017	HV-38-0027
HV-38-0008	HV-38-0018	HV-38-0028
HV-38-0009	HV-38-0019	HV-38-0029
HV-38-0010	HV-38-0020	HV-38-0030

SINGLE HV BOX (BATCH 38)

- Step 1:** Turn your HV BOX Off and connect the CAN cable into the port CAN 1A
- Step 2:** Plug the RJ45 termination provided with the kit into the port CAN 2A
- Step 3:** Turn on the HV BOX and the solar inverter

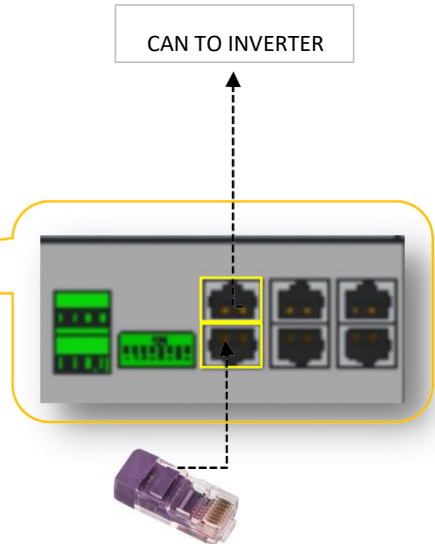
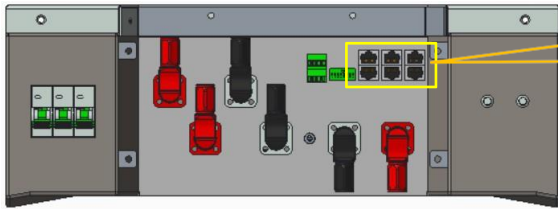

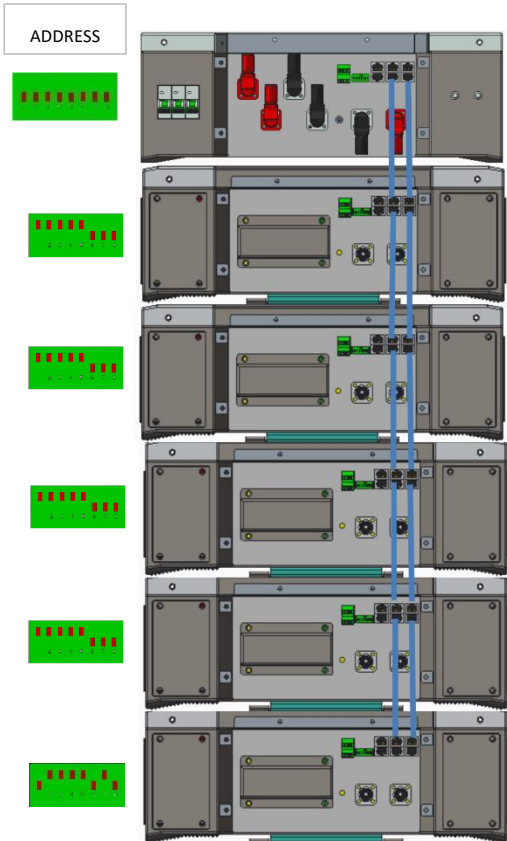

SINGLE CLUSTER WITH CAN ADDRESS 00

PLUG THE CAN TERMINATION 120 Ω



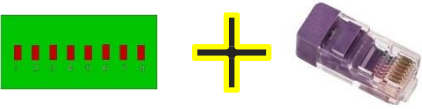

If your HV BOX is present in the list shown above, make sure to set the DIP switch terminal to 0-0-0-0-0-0-0 and plug the termination into the port CAN 2-A

COUPLE OF HV BOX ADDRESSED 00 and 01 (BATCH 38)



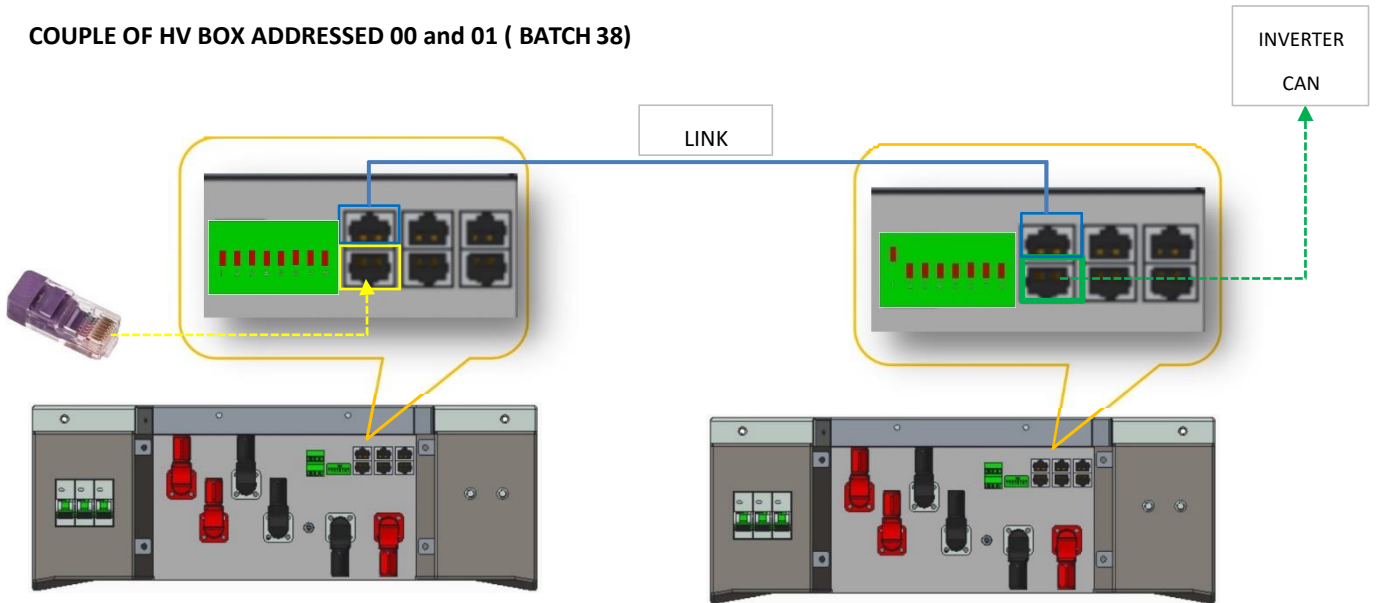



How connect an HV model BATCH 38 with a new HV BOX with Batch Number higher than -40-

If you have an existing system (BATCH 38) and you are going to expand the system capacity with a new HV BOX m (BATCH 40 or Above) you can follow the instruction below to successfully set up you system.



Connection and Settings for HV BOX (Batch 40 or Above)



SINGLE HV BOX

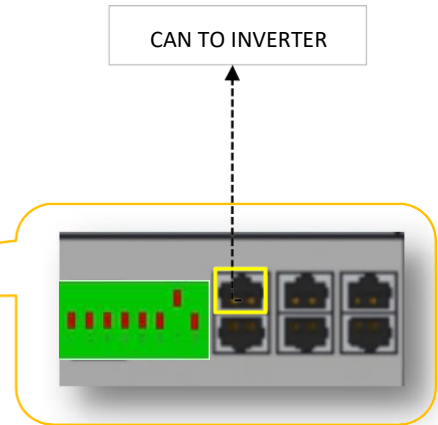
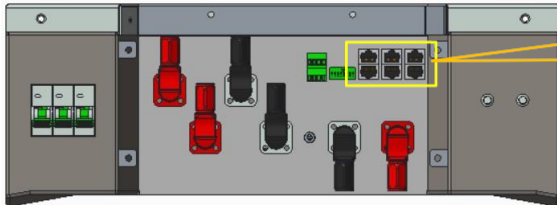

SINGLE CLUSTER WITH CAN ADDRESS 00

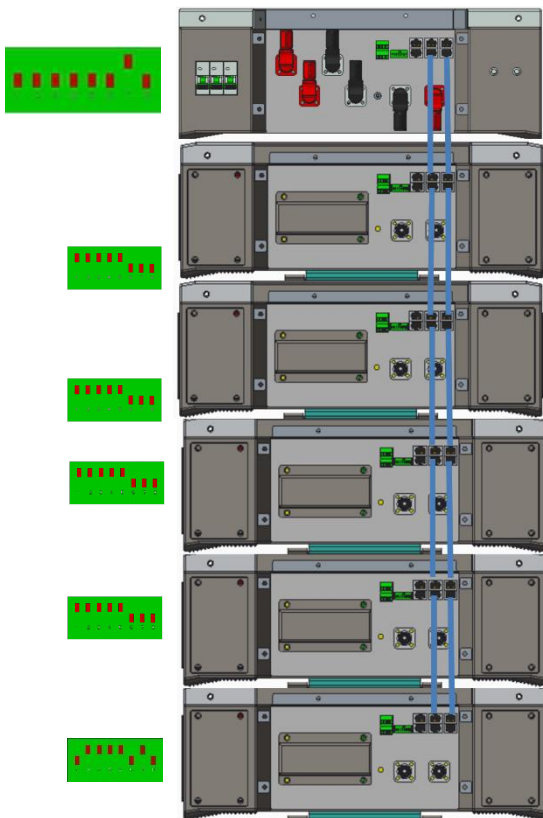

If your HV BOX is part of the batch 40 or above, make sure to set the DIP switch terminal to 0-0-0-0-0-1-0



DON NOT USE THE RJ45 RESISTOR FOR THIS BATCH

3.5.4 MULTI HV BOX CONNECTION (BATCH 40 or ABOVE)

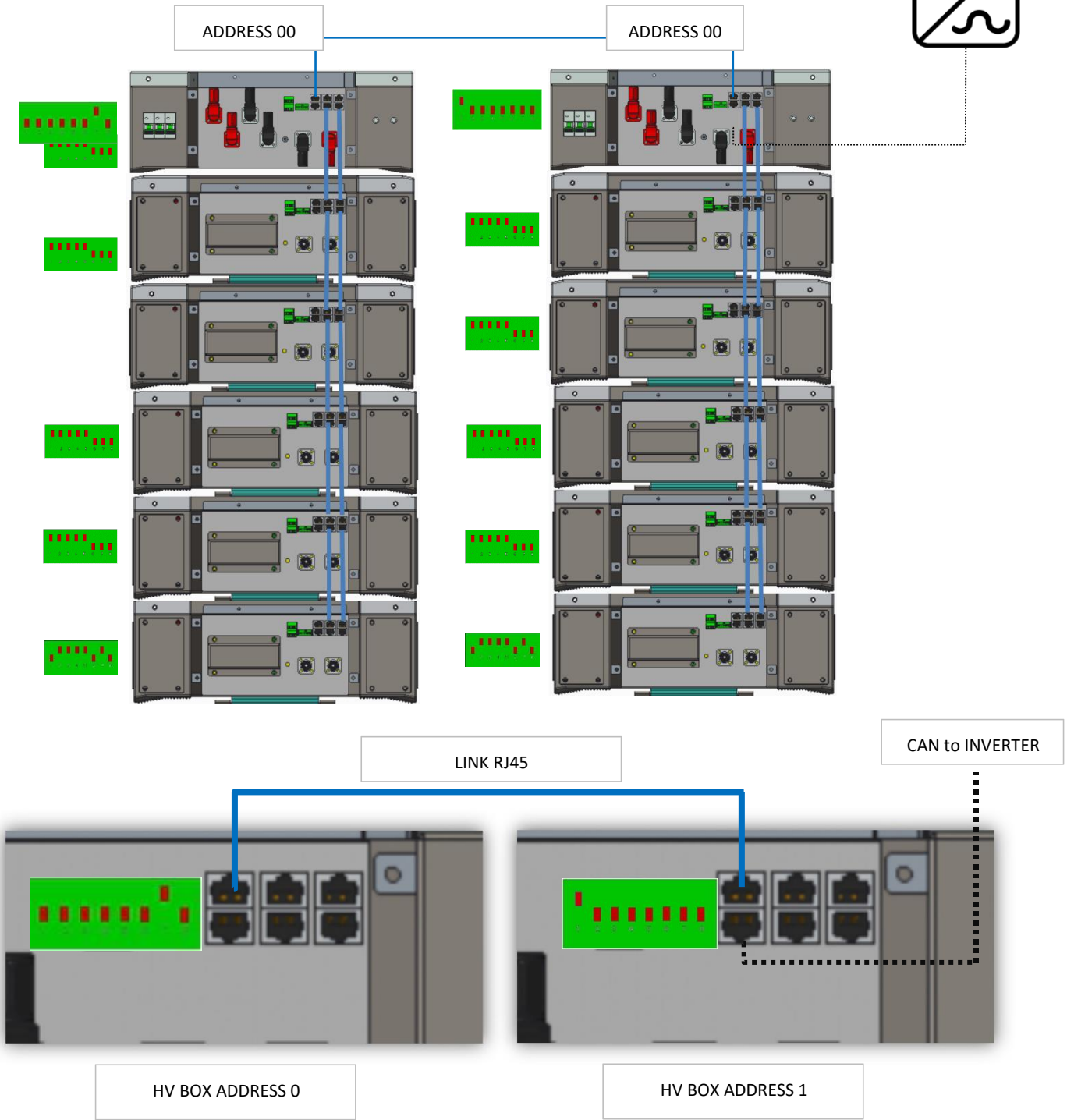

H
I
G
H
V
O
L
T
A
G
E

3.6 HV BOX ADDRESS (ALL BATCHES)

	HV BOX ADDRESS	DIP1	DIP2	DIP3	DIP4	DIP5	DIP6	DIP7	DIP8
	Adres after the setting	1	2	3	4	5	6	7	8
0	HV BOX Address 00	OFF	OFF	OFF	OFF	reserved	reserved	ON-with Terminal resistance OFF-no Terminal resistance	reserved
1	HV BOX Address 01	ON	OFF	OFF	OFF	reserved	reserved	ON-with Terminal resistance OFF-no Terminal resistance	reserved
2	HV BOX Address 02	OFF	ON	OFF	OFF	reserved	reserved	ON-with Terminal resistance OFF-no Terminal resistance	reserved
3	HV BOX Address 03	ON	ON	OFF	OFF	reserved	reserved	ON-with Terminal resistance OFF-no Terminal resistance	reserved
4	HV BOX Address 04	OFF	OFF	ON	OFF	reserved	reserved	ON-with Terminal resistance OFF-no Terminal resistance	reserved
5	HV BOX Address 05	ON	OFF	ON	OFF	reserved	reserved	ON-with Terminal resistance OFF-no Terminal resistance	reserved
6	HV BOX Address 06	OFF	ON	ON	OFF	reserved	reserved	ON-with Terminal resistance OFF-no Terminal resistance	reserved
7	HV BOX Address 07	ON	ON	ON	OFF	reserved	reserved	ON-with Terminal resistance OFF-no Terminal resistance	reserved
8	HV BOX Address 08	OFF	OFF	OFF	ON	reserved	reserved	ON-with Terminal resistance OFF-no Terminal resistance	reserved
9	HV BOX Address 09	ON	OFF	OFF	ON	reserved	reserved	ON-with Terminal resistance OFF-no Terminal resistance	reserved
10	HV BOX Address 10	OFF	ON	OFF	ON	reserved	reserved	ON-with Terminal resistance OFF-no Terminal resistance	reserved
11	HV BOX Address 11	ON	ON	OFF	ON	reserved	reserved	ON-with Terminal resistance OFF-no Terminal resistance	reserved
12	HV BOX Address 12	OFF	OFF	ON	ON	reserved	reserved	ON-with Terminal resistance OFF-no Terminal resistance	reserved
13	HV BOX Address 13	ON	OFF	ON	ON	reserved	reserved	ON-with Terminal resistance OFF-no Terminal resistance	reserved
14	HV BOX Address 14	OFF	ON	ON	ON	reserved	reserved	ON-with Terminal resistance OFF-no Terminal resistance	reserved
15	HV BOX Address 15	ON	ON	ON	ON	reserved	reserved	ON-with Terminal resistance OFF-no Terminal resistance	reserved

3.6.1 LED Visual Indication Lights

- Power Button
- Each single module has its own run button but the HV box will take over the communication by activating or switching off the HV module circuit

3.6.1.1 Power Button

The Power Button is located to the right of the battery terminal connections on the side of the battery. The Power Button is a multi-color button and will provide the user with the following indications depending on the state of the battery

A 2-second press on the Power Button will turn the battery module on.

A 5-second press on the Power Button will turn the battery off

Other functions of the Power Button are explained in the relevant sections of this manual.



Attention: Read this entire manual thoroughly to understand the correct start up and shut down procedures for each battery configuration.



Attention: Illustrations shown are for reference only, please always refer to the physical battery module in front of you and if the module has a different configuration to this manual, stop all activity immediately and contact WeCo support on service@weco.uk.com.

3.6.2 Stand Alone Battery Front Panel Control * FORCED CHARGE*

3.6.2.1 Start Battery

Press the power button of the HV BOX for 3 or more seconds (depends by the system status)

The GREEN RUN light should come on. The HV BOX module has been activated normally and the batteries modules should come on automatically, if not press the run button of each module and wait for the HV BOX string diagnosis, if the HV BOX will show the warning led light (RED) turn the string OFF and connect the PC software for debug.

3.6.2.2 Shut Down batteries and HV Box

Long press the power button for five seconds of the run button of the HV box.

The GREEN RUN light should go off. The HV BOX has been shut down normally.

By switching off the HV BIX all the battery modules should turn off automatically, if not then shut down manually by pressing the run button for 5 seconds.

3.6.2.3 Low Voltage Setting of the Battery for emergency / forced Charge



ATTENTION: The HV connection cables must be disconnected; the force charge implies to follow the LV section rules.

THE FORCED CHARGE MUST BE PERFORMED AS SINGLE LOW VOLTAGE MODULE

SET THE DIP SWITCH AS PER THE PICTURE BELOW

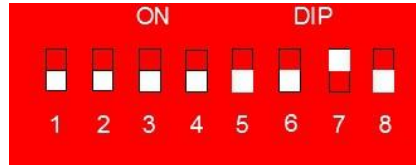

ATTENTION: Before performing any operation on the battery make sure that the **VOLTAGE** between the battery B+ and B- terminals in the terminal BLOCK LOW VOLTAGE SECTION is **ZERO (0Vdc)** and the **PANEL LIGHTS ARE OFF**.

Battery is in “Shutdown State”, only after the charging device is connected the operator can turn on the battery by pressing the RUN button

Each Module must be electrically isolated from other modules, remove all the serial connections cables.

Preparation condition before forced charging: Connect the charger or the inverter with charging capability to the B+ and B- of the battery box to ensure charging capacity.

Forced charging approach: Short press the battery power button, the battery RUN light will flash green, which means that the battery is entering the compulsory charging mode. If the battery receives an adequate charging power (above 10 Amps/58V) within 90 seconds from pressing the button, the battery will continue to charge normally until a stable state is reached.

If the battery does not receive adequate charging power within 90 seconds after pressing the button, the battery will enter the shutdown mode once again.

During the forced charging period the low battery LED will be steady orange up to an SOC of 10% at which point the low battery LED will go out.



ATTENTION: Each module must be recharged at the same SOC. The Inspection must be done by using the RS232 and LV PC software provided by WeCo tech. Service.

This process may take long time and the installer must be prepared to do this operation



ATTENTION: When the charging process of each module has been concluded, the serial connection must be restored by following this manual's instruction.

HV Product Compatibility List + Maximum Modules Admitted per Cluster

3.7.1 Direct Serial with CAN Communications for each HV Box

Number	Inverter brand	Inverter model	UNITS PER CLUSTER *max	HeSU 5.3 LFP with HV BOX 750Vdc
01	ZCS Azzurro	HYD 10000	12	12 x 5.2kWh x 9 Clusters= 561 kWh
02		HYD 15000	12	
03		HYD 20000	12	



ATTENTION

DO NOT EXCEED THE MAXIMUM VOLTAGE OF 750Vdc

DO NOT CONNECT MORE THAN 12 MODULES IN SERIES

3.7.2 Direct Connection without CAN Communications

IT IS NOT ALLOWED TO CONNECT HV MOUDULES WITHOUT CONNECTING THE HV BOX



ATTENTION: Do not connect HIGH VOLTAGE inverter with WeCo Batteries without WeCo HV BOX and the corresponding customized inverter protocol provided by WeCo.

Using the batteries without an approved communication protocol and without a HV protection hardware may lead to fire and personal injuries.

High Voltage inverter can be connected with WeCo batteries only if approved by WeCo

TEMPERATURE/ C-RATE	1C + Overload	0.5C
CHARGE	-8°C +55°C	-9°C – 15°C
DISCHARGE	-20°C +50°C	+55°C +65°C

CHARGING CURVE SET	Charge 0% to 90% Discharge 100% 90%	Charge 90%-100% Discharge 10%-0%
CHARGING	-100A	-20A
DISCHARGING	100A	20A



ATTENTION: The charge and discharge current of the inverter **MUST** be limited according with the maximum current allowed by each cluster configuration

The charge and discharge Voltage range of the inverter **MUST** be limited as per the module maximum value



NOTE:

This manual is subjected to continuous implementation.

Before installing your WeCo batteries please contact our assistance team in order to have the latest manual and any additional support.

Safety improvement is our priority, please cooperate with us to improve the system, any suggestion is well accepted.

WeCo Srl Italia

WeCo FZ LLC United Arab Emirates