



## Installation and User Manual



**DD5300 Energy Storage System**

**LOW VOLTAGE & HIGH VOLTAGE**



**ATTENTION:** The battery could explode and/or be severely damaged if dropped or crushed.



**ATTENTION:** Appropriate mechanical lifting equipment must be used since the Battery Module weighs 126.3 lb (57.3 kg).



**ATTENTION:** The battery may explode if exposed to open flames or other extreme sources of heat.



**ATTENTION:** The battery terminals must be disconnected before commencing any work on the battery.



**ATTENTION:** This battery can accumulate parasite current. Do not touch the B+ and B- terminals. Always check the B+ and B- terminals with a voltmeter.

**Always ensure that there are ZERO volts present on the terminals before performing any operation on the battery.**

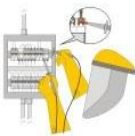

**ATTENTION:** Always wear Individual protection devices, use insulated tools, and follow the safety plan of this manual.



**At end of life, these batteries must be disposed of properly by a certified professional company.**

Contents

**Statement: ..... 6**

**Preface: ..... 6**

**Declaration: ..... 6**

**System Design ..... 7**

**Battery Operation ..... 7**

    Storage ..... 7

    Temperature ..... 7

    Depth of Discharge (DoD)..... 7

    Charging..... 7

    Warranty..... 7

**Product Overview ..... 8**

**Symbols Used..... 8**

**Battery Module Overview ..... 9**

**Safety Warnings and Notifications.....11**

**Warning Statements .....12**

**General Preparation.....13**

**SECTION 1 - STORAGE & PRE-OPERATIONAL PROCEDURES.....16**

    1.1 Storage - Transportation – Removing / Relocation of Batteries ..... 16

    1.2 Module Unpacking and Handling ..... 18

        1.2.1 Package Information and System Configuration List ..... 19

    1.3 Wall Mount or Stack Mount Configuration ..... 19

        1.3.1 Battery Dimensions\* (Wall Bracket) ..... 19

        1.3.2 Wall Mount ..... 19

1.3.3	Stack Mount .....	23
1.4	Battery Terminal Function Definition.....	25
1.5	Out of the Box Pre-Operational Check.....	26
<b>SECTION 2 - LOW VOLTAGE CONFIGURATION .....</b>		<b>27</b>
2.1	Product Introduction .....	27
2.1.1	Identifying the Individual Module.....	27
2.1.2	Accessory List (Standard Kit 120A Single Module LV).....	29
2.1.3	Necessary Installation Tools.....	30
2.1.4	Personal Protective Equipment +1000 Vdc Insulated Tools .....	30
2.2	Low Voltage Module Wiring and Set Up.....	31
2.2.1	Battery Connection Terminals .....	31
2.2.2	BATTERY CAN Pin Out .....	31
2.3	Low Voltage DIP Switch Settings .....	32
2.3.1	LOW VOLTAGE PARALLEL CONFIGURATION.....	33
2.3.2	LED Visual Indication Lights .....	33
2.4	Module Activation and Shutdown.....	33
2.5	Low Voltage Parallel Set Up Overview.....	35
2.5.1	Auto ID Assignment and DIP Configuration for LOW Voltage Single Cluster (Parallel Connection) .....	36
2.5.2	Single Cluster DIP and DATA Connection .....	38
2.5.3	Parallel Battery Wiring Connections .....	39
2.5.4	Low Voltage Single Stack Power and Data Connections (15-Modules Maximum).....	40
2.5.5	LED Bar Indications.....	42
2.6	Stand Alone Battery Front Panel Control .....	43
2.6.1	Start Battery.....	43
2.6.2	Shut Down Battery .....	43
2.6.3	Low Battery – Force Charge.....	43
2.7	Parallel Battery Configuration.....	43
2.7.1	Activation of Parallel Batteries (From Master to last module for a maximum of 15) .....	43
2.7.2	Shutdown of Parallel Batteries .....	44
2.7.3	LV Direct Parallel Connection WITHOUT Certified Inverter BMS Communication (Open-Loop) .....	45
2.7.4	LV Direct Parallel Connection WITH Certified Inverter BMS Communication (Closed-Loop) .....	46
2.8	Power Connection of a Single Cluster .....	47
2.9	CAN HUB for Multi Cluster Configuration .....	49
2.9.1	Low Voltage CAN HUB Dimensions.....	51
2.9.2	Control Logic and Protection Limit.....	51
2.9.3	CAN Hub General System Description .....	52
2.9.4	Multi Cluster Configurations.....	53
2.9.5	Master ID Set Up and Connection Diagram.....	54
2.9.6	Power Connection Example.....	55
2.9.7	Conceptual Diagram of a Cluster composed by 5 clusters and 8 batteries each.....	56

2.9.8 Conceptual Diagram between Master Modules of multiple clusters.....	57
<b>2.10 Cluster Configuration Accessories .....</b>	<b>58</b>
2.10.1 Single Cluster Configuration Kit .....	58
2.10.2 Multi Cluster Hub Device .....	58
<b>2.11 Low Voltage Inverter Compatibility List .....</b>	<b>59</b>
<b><u>SECTION 3 - HIGH VOLTAGE CONFIGURATION .....</u></b>	<b><u>61</u></b>
<b>3.1 Product Introduction .....</b>	<b>62</b>
3.1.1 Identifying the Individual Battery Module .....	62
3.1.2 Product Identification and labels .....	63
3.1.3 HV BOX Dimensions .....	64
3.1.4 Battery Module Accessory List (Standard Kit) .....	65
3.1.5 HV BOX KIT (Included in the carton box).....	66
3.1.6 Necessary Installation Tools.....	67
3.1.7 Personal Protective Equipment + 1000 Vdc Insulated Tool Kit .....	67
<b>3.2 High Voltage Battery Module Wiring and Set Up.....</b>	<b>68</b>
3.2.1 Battery Connections .....	68
<b>3.3 HV BOX Overview .....</b>	<b>70</b>
<b>3.4 High Voltage Module Configuration.....</b>	<b>72</b>
<b>3.5 High Voltage DIP Switch Settings .....</b>	<b>73</b>
3.5.1 Serial Tower Connection #1 Set-Up of the HV Box CAN Communication Loop.....	74
<b>3.6 Serial Battery Wiring Connections.....</b>	<b>75</b>
3.6.1 High Voltage Power Connections .....	76
3.6.2 DATA Connections (Example of 12-Modules).....	77
3.6.3 HV Box and Battery Module Power Connection .....	79
3.6.4 Single HV Box Connection to an Inverter .....	80
3.6.5 Multi HV Box Connection .....	81
3.6.6 Multi HV Box Connection .....	82
<b>3.7 HV Box ADDRESS.....</b>	<b>83</b>
3.7.1 LED Visual Indication Lights .....	85
3.7.2 Stand-Alone Battery Front Panel Control * FORCED CHARGE* .....	85
<b>3.8 HIGH VOLTAGE INVERTER COMPATIBILITY .....</b>	<b>87</b>
<b>3.9 WECO BMS - LOW VOLTAGE PC SOFTWARE for DD5300 .....</b>	<b>88</b>
<b>3.10 WECO BMS - HIGH VOLTAGE PC SOFTWARE for DD5300 .....</b>	<b>92</b>

## Statement:

The information and guidance contained in this manual is related to the **DEKA DD5300** Stackable model of battery. This manual contains two sections:

**Section 2 is for LOW VOLTAGE APPLICATION**  
**Section 3 is for HIGH VOLTAGE APPLICATION**

In case of product upgrades or other reasons, this document will be adjusted accordingly. Unless otherwise agreed, this document is intended to be used only as a guide, and all statements, information and advice in the documentation shall not constitute any express or implied action in contradiction to local regulations or standards.

For more information, please contact us.

The official information and the latest data sheet are available on [www.mkbattery.com](http://www.mkbattery.com)

It is essential that the Battery Module is equipped with the latest firmware version available.

New batteries always ship with the latest version of firmware.

From time to time, firmware will be updated to improve the functionalities and battery capabilities. The latest version of the firmware is always available free of charge and can be updated by your local installer. You can always contact [durationsupport@dekabatteries.com](mailto:durationsupport@dekabatteries.com) for additional information on the upgrade procedure.



### NOTICE:

This Battery Module is designed to be used indoors.

The STANDARD IP20 degree of protection does not allow installation in outdoor environments even if sheltered from the weather.

The Battery Modules must be stored indoors in a clean, dry, cool location in a limited access area.

## Preface:

Thank you for choosing our product. We will provide you with a high-quality product as well as reliable after-sale service. To protect against harm to both personnel and the product, please read this manual carefully.

This manual provides detailed information on operation, maintenance and troubleshooting of the product as well as health and safety advice.

## Declaration:

The manufacturer holds the right of final explanation of any content in this manual.

All trademarks shown in this manual belong to their legitimate owners; trademarks of third parties, product names, trade names, corporate names and companies mentioned may be trademarks owned by their respective owners or registered trademarks of other companies and are used purely for explanatory purposes and for the benefit of the owner, without any purpose of violation of the copyright in force.

## System Design

System Design is the process of defining the architecture, components, modules, interfaces and load data for a system to satisfy specified requirements.

For a solar energy system, these components are the PV modules, inverter/charge controller & batteries, as well as the different interfaces of those components.

## Battery Operation

There are several factors that affect the operation of the battery that could impact its ability to deliver capacity and life expectancy.

### Storage

Battery Module shall be stored in original packaging, in a clean, level, dry, cool location indoors.

Recommended storage temperature is 77°F (25°C).

The battery can be stored in the range of -4°F to +113°F (-20°C to +45°C) but it requires an inspection\* and recharge\*\* every three months (max charging current is 0.1C).

Max SoC storage % is 50%.

\*Inspection parameters – identify the State of Charge (SOC), look for any alarms and address accordingly, look for physical damage to the Battery Module. \*\*Charge at 0.1C and not more than 50% SOC. If shipped by sea, you must refer to the UN38.3 standard, if by road, refer to the local codes.

### Temperature

Many chemical reactions are affected by temperature, and this is true of the reaction that occurs in a storage battery.

The chemical reaction of a Li-Ion is slowed down by a lowering of the electrolyte temperature that results in less capacity.

A battery that will deliver 100% of rated capacity at 77°F (25°C) will only deliver approximately 75% of rated capacity at +50°F (+10°C).

At temperatures down to +19.4°F (-7°C) the charge current may be limited to 0.1C depending on other factors, however at temperatures below +19.4°F (-7°C) charging is restricted by the BMS.

As part of the Performance Warranty, Charge and Discharge shall be in the range +68°F to +77°F (+20°C to +25°C). Any usage outside this range is not covered by Performance Warranty.

### Depth of Discharge (DoD)

Depth of discharge is a function of design. The deeper the discharge per cycle, the shorter the life of the battery. A cycle is a discharge and its subsequent recharge regardless of depth of discharge.

### Charging

The majority of battery capacity/life issues can be traced to improper charging. Improper charging settings may lead to an overcharging or undercharging condition.

### Warranty

Although the BMS of the battery allows a wide range of use, both in terms of temperature and charging currents, this should not be construed as an implicit authorization to use the battery at these levels.

For the purposes of the Performance Warranty, it is mandatory that the battery is used within the range of temperature and charge/discharge current, and Depth of Discharge indicated in the Performance Warranty.

Warranties only apply to batteries connected via BMS line to an approved inverter.

Any other use, even if permitted by the BMS ranges, is not covered by the Performance Warranty.

## Product Overview

The Deka Duration DD5300 is a Stackable Battery Module with a DUAL VOLTAGE module that can be used in a Low Voltage configuration or in a High Voltage configuration.

For LOW VOLTAGE (48.5-58.4 Vdc)\* Configuration Refer to Section 2

For HIGH VOLTAGE (200-934.4 Vdc)\* Configuration Refer to Section 3

\*Voltage ranges are estimates only as they always depend on interactions with other devices and ambient conditions.

## Information in this Manual

### About this Manual

This manual relates only to the DD5300 Stackable Battery Module. Only trained and authorized personnel should install, repair or charge these Battery Modules. This manual should be reviewed in its entirety for proper storage, installation and operation of the Battery Module.

### Use Range

This installation guidance applies for the High Voltage and Low Voltage Inverters.

Make sure to use the correct inverter charging parameters before connecting to the battery.

Each Deka Duration DD5300 Battery Module has two different circuits and depending on the inverter voltage range, the installer must choose the correct battery configuration for that range.

### Additional Information

Product specifications subject to change without notice.



#### IMPORTANT NOTICES:

HV BOX minimum startup voltage is 150 Vdc, (three modules) however it is suggested to use a minimum of four modules to have an adequate buffer of energy to prevent low voltage shutdown of the HV BOX during a long period of the inverter on standby, or due to solar charger inactivity.

The Deka Duration DD5300 Stackable Battery Module is designed for home and commercial applications from 5.3 kWh to 556.5 kWh in Low Voltage configuration and from 21.2 kWh to 763.2 kWh in High Voltage configuration.

For the calculation of the energy of a cluster (in both LV and HV systems) the nominal capacity of a battery is generally counted in 5.3kWh as a result of the multiple connection inefficiency, estimated at a loss of 2%.

### Symbols Used

Symbol Meanings:



#### CAUTION:

CAUTION represents hazardous situations which can cause injuries if not avoided.



#### NOTICE:

NOTICE represents the situations which can cause damage to property if not avoided.



#### INFORMATION:

INFORMATION provides tips that are valuable for optimum installation and operation of the product.



## Battery Module Overview

INFORMATION provides tips that are valuable for optimum installation and operation of the product.

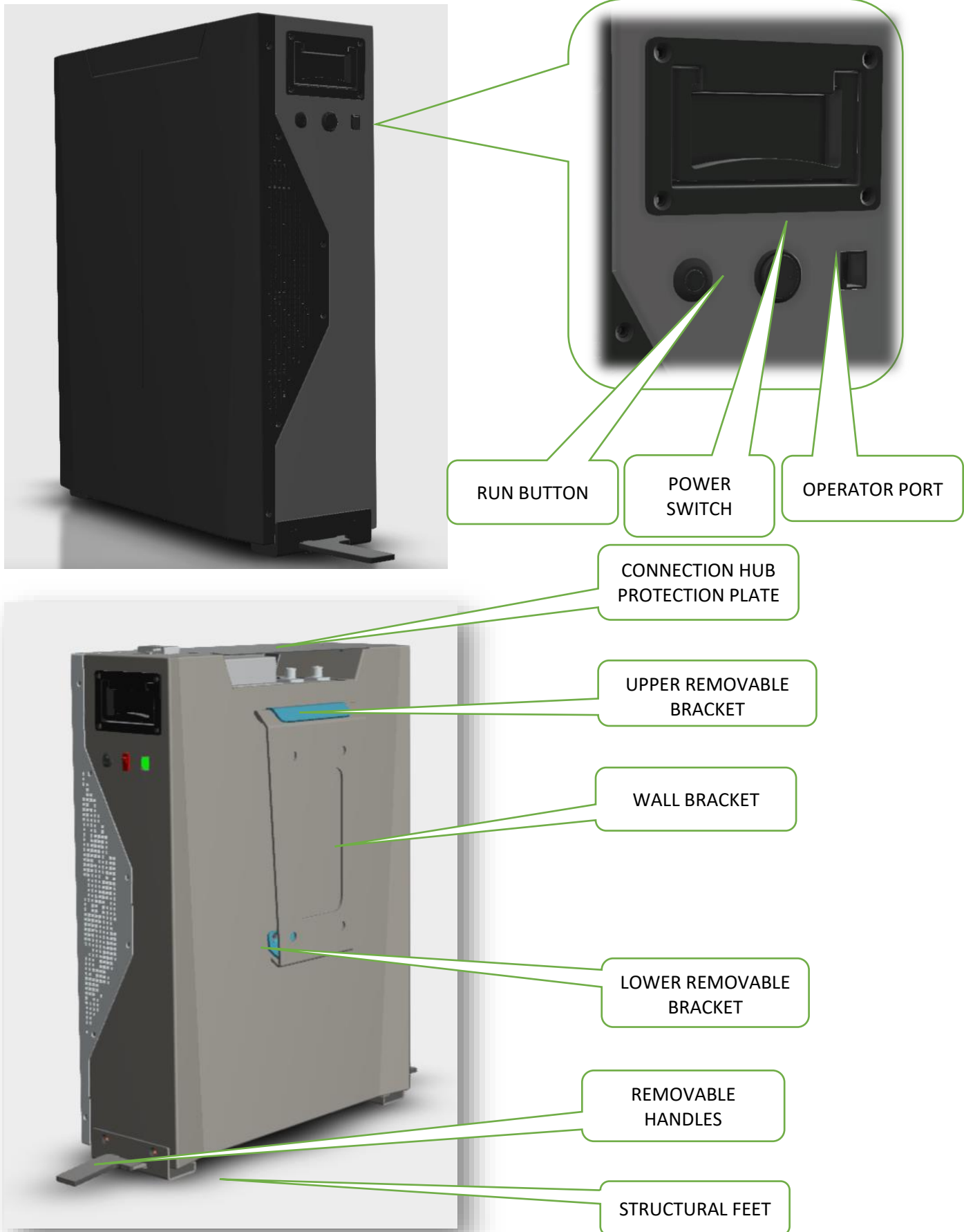



**ATTENTION:**

**THE BATTERY IS DUAL VOLTAGE –**

**IT CAN BE INSTALLED IN EITHER A HIGH VOLTAGE CONFIGURATION OR A LOW VOLTAGE CONFIGURATION,  
BUT NEVER BOTH AT THE SAME TIME.**

**BE AWARE OF THE DIFFERENT CONNECTION METHODS AND THE SPECIFIC USE OF THE TERMINAL  
CONNECTORS.**

**LOW VOLTAGE ONLY  
SCREW TERMINAL**

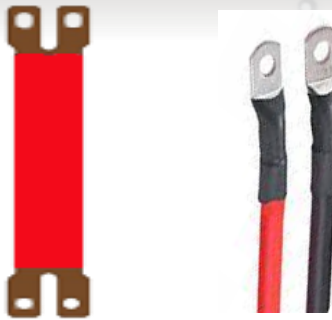

**HIGH VOLTAGE ONLY  
FAST CONNECTORS**

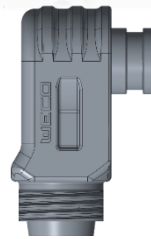
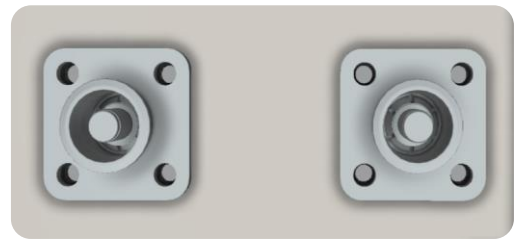

**LOW VOLTAGE  
PARALLEL CONNECTION**

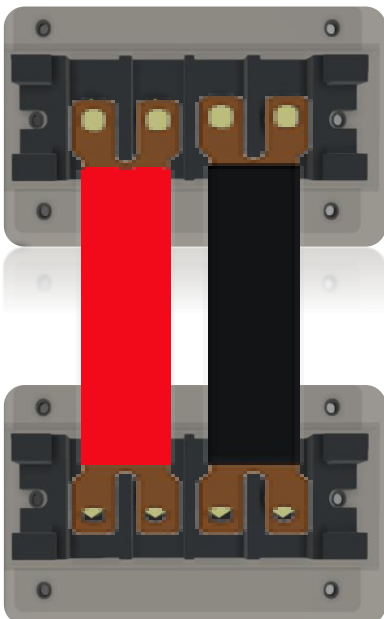

**HIGH VOLTAGE  
SERIAL CONNECTION**

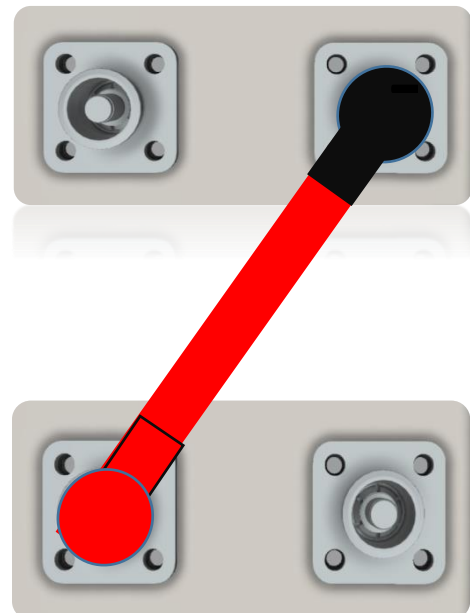

## Safety Warnings and Notifications

Installation environment requirements: The Deka Duration DD5300 Stackable Battery Module is designed for household/commercial purposes. For installation, it must be installed in a location complying with IP20 (IP 55 or 65 are available on request). Installations in locations that do not comply with IP20 may cause failure and/or damage to the product, in which case the product warranty will become void.

### Safety Guidelines



#### CAUTION:

Adequately insulated tools (as defined by ASTM F1505 “Standard Specification for Insulated and Insulating Hand Tools” shall be used at all times to ensure battery terminals are not short circuited. All electrical connections on the Deka Duration DD5300 Battery Module shall be made only by qualified personnel.

When installed and operated in accordance with this manual, the Deka Duration DD5300 Battery Module will perform in a safe and reliable manner in accordance with the battery operating specifications.

Subjecting the battery to an unsuitable operating environment or to damage, misuse or abuse may result in health and safety risks such as overheating or electrolyte smoke potential. All personnel must comply with the safety precautions and observe all warnings as detailed in this document. If any of the safety precautions or procedures detailed in this manual are not fully understood by the reader, the reader must not perform any operation on the battery until they have contacted the DEKA DURATION technical service representative for clarification and confirmation of understanding of the correct procedure.

The safety guidelines included in this document may not include or consider all the regulations in your area of installation/operation. When installing and operating this product, the installer must review and consider applicable Federal, State and Local laws and regulations in accordance with the industry standards of the product.

Installation personnel shall not wear metallic objects, such as watches, jewelry and other metal items when performing installations. Do not store un-insulated tools in pockets or tool belt while working in vicinity of battery to avoid short circuits and personal injuries.



#### CAUTION:

The weight of an individual Deka Duration DD5300 Battery Module is 126.3 lb (57.3 kg). Please use original packaging and follow all safety precautions if the Battery Module is to be relocated to another location, to avoid damage to the product and personal injury.



#### ATTENTION:

**The high voltage configuration must have a minimum number of 4 modules in order to reach at least 200 Vdc in series. The maximum number of modules that can be stacked is 8 on each tower (due to the tower height and stability) and the maximum number of modules composing an HV string must not exceed 16.**

## Warning Statements



### Lithium Iron Phosphate (LiFePO4) Battery or Cell DANGER

#### Hazard Statement

The materials contained in this product may only represent a hazard if the integrity of the cell or battery is compromised; physically, thermally, or electrically abused. The below are the hazards anticipated under those conditions: Causes skin irritation. Causes serious eye irritation. May cause an allergic skin reaction. Causes damage to organs (Bone, teeth) through prolonged or repeated exposure. Very toxic to aquatic life. Harmful to aquatic life with long lasting effects.

#### Precautionary Statement

##### Prevention

Do not breathe dust. Do not eat, drink or smoke when using this product. Wear protective gloves/protective clothing/eye protection/face protection. Wash thoroughly after handling. Contaminated work clothing must not be allowed out of the workplace. Avoid release to the environment.

##### Response

If on skin: Wash with plenty of water. If skin irritation or rash occurs: Get medical advice/attention. Take off contaminated clothing and wash it before reuse. If in eyes: Rinse cautiously with water for several minutes. Remove contact lenses, if present and easy to do. Continue rinsing. If eye irritation persists: Get medical advice/attention. Get medical advice/attention if you feel unwell. Collect spillage.

##### Storage

Store as indicated in the Storage section of this manual.

##### Disposal

Dispose of contents/container in accordance with local/regional/national/international regulations.

#### Supplemental information

Under normal conditions of processing and use, exposure to the chemical constituents in this product is unlikely. The chemicals are contained in a sealed steel housing. Risk of exposure occurs only if the battery is mechanically, thermally or electrically abused. If this occurs, exposure to the electrolyte solution contained within can occur by inhalation, ingestion, eye contact and skin contact.

Additional Notes: CAUTION: Do not dispose in fire, mix with other battery types, charge above specified rate, connect improperly, or short circuit, which may result in overheating, explosion or leakage of cell contents. Do not open or disassemble. Do not puncture, deform, incinerate or heat above 85°C (185°F). Keep away from heat/sparks/open flames/hot surfaces. - No smoking.

This product is a "Hazardous Chemical" as defined by the OSHA Hazard Communication Standard, 29 CFR 1910.1200. Additional information is given in the Safety Data Sheet.

Emergency Number USA/Canada: CHEMTREC (800) 424-9300, Outside USA 1 (703) 527-3887



**WARNING:** This product can expose you to chemicals including Carbon black, which is known to the State of California to cause cancer, birth defects or other reproductive harm. For more information go to [www.P65Warnings.ca.gov](http://www.P65Warnings.ca.gov).

## General Preparation

Before Installation:

Ensure that all the modules are turned OFF.

Battery installation location should be at least 20m away from sources of heat, sparks or other sources of extreme temperature. Battery connecting cables shall be as short as possible to prevent excessive voltage drops.

Batteries with different capacity, different type/model or design or from different manufacturers shall not be connected together.

1. Before connecting the battery, the battery positive and negative poles shall be carefully checked to ensure correct installation.
2. The installation location must be on a flat level surface, in a dry, clean and protected room, away from water and humidity.



The mechanical installation method for the Deka Duration DD5300 Battery Modules can be considered “conceptually” the same for HV and LV configurations.

Before starting any operation on the battery, make sure to position the modules in their final position and structurally fix all the modules that make up the system.

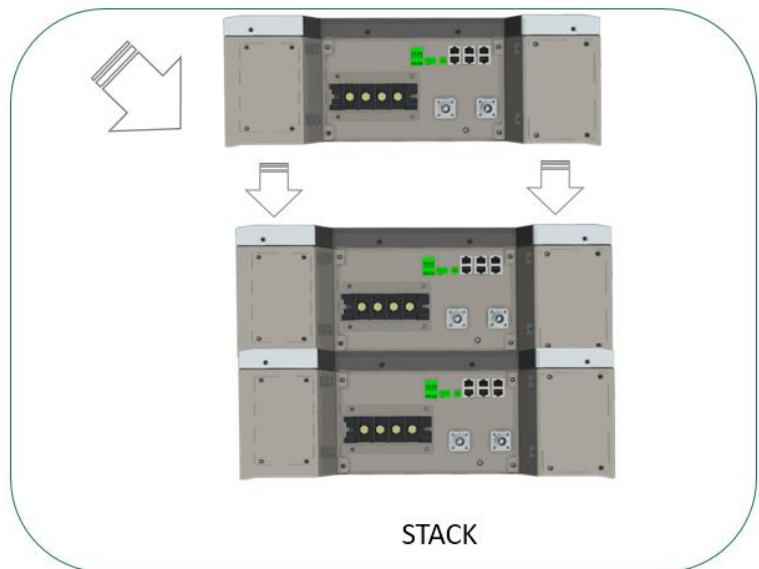

The installer who intends to install the Deka Duration DD5300 Battery Module in the HV configuration should read this entire manual including the HV configuration information defined in Section 3.



**ATTENTION:  
STACKABLE INSTALLATION INFORMATION**

The stack configuration shall be concluded by interlocking the modules by using the module feet as shown below:

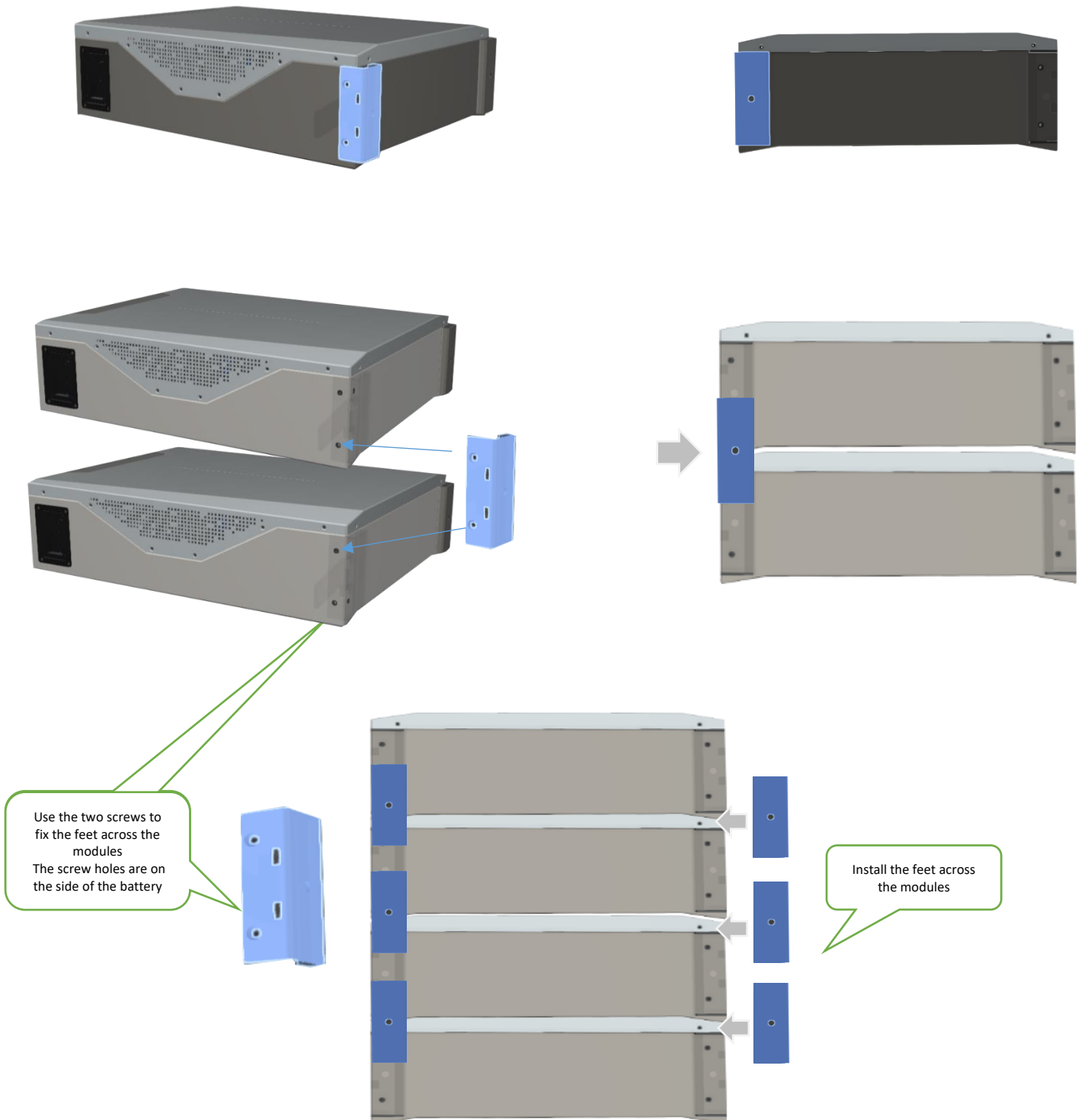

When operating in stack mode, remove the upper (trapezoidal) front part from the Battery Module to allow the cables to pass through. The front plate must be reinstated to protect the cables after the installation is complete.

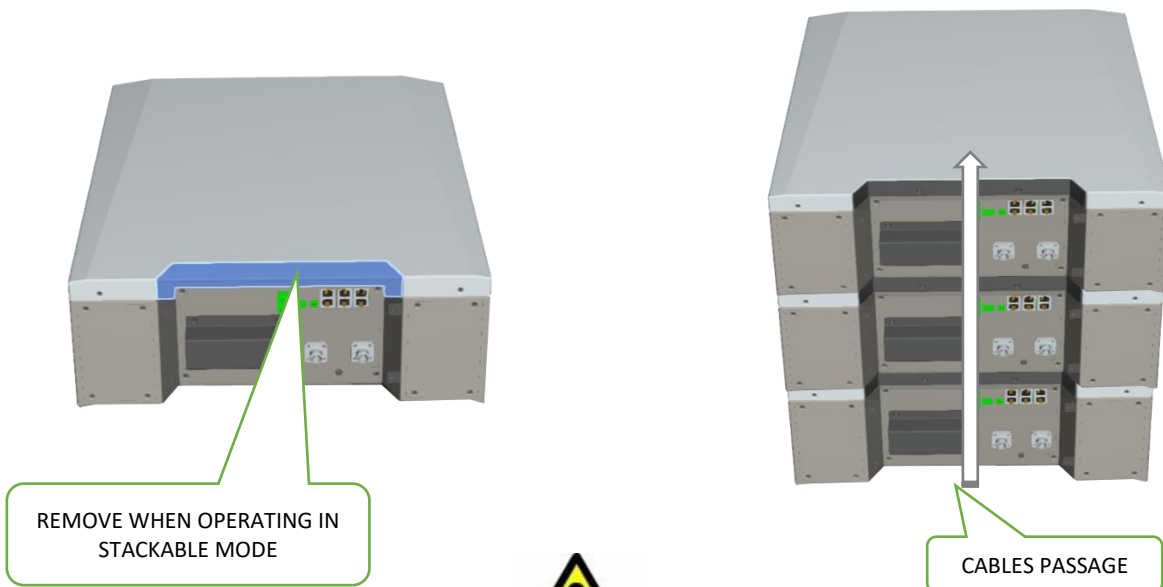

**ATTENTION:**

The DD5300 Battery Module has two terminals for connecting the power supply. The installer must pay the utmost attention to the respective functions.

LOW VOLTAGE  
PARALLEL CONNECTION

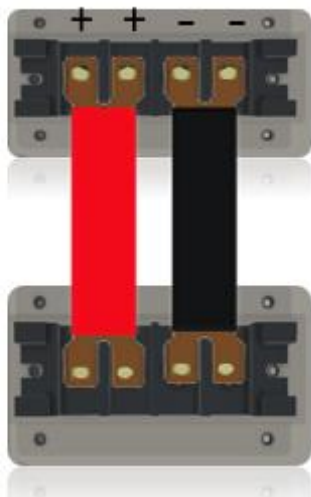

HIGH VOLTAGE  
SERIAL CONNECTION



The low voltage screw terminal only supports parallel connection with maximum voltage 60V  
CAUTION> Connecting these terminals in series will cause serious damage to the battery  
**DO NOT CONNECT IN SERIES**

Fast Connector terminals only support series connections up to 1000Vdc  
CAUTION> Connecting these terminals in parallel will cause serious damage to the battery  
**DO NOT CONNECT IN PARALLEL**

## SECTION 1 - STORAGE & PRE-OPERATIONAL PROCEDURES

### 1.1 Storage - Transportation – Removing / Relocation of Batteries

- ✓ This Battery is considered DANGEROUS GOODS by the United Nations and must be treated accordingly.
- ✓ Each box comes from the factory with the below labels:

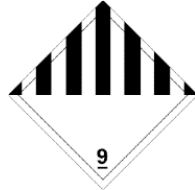

- ✓ This battery can only be transported and stored with the original approved carton box, Certified as per UN CLASS 9 Y80.
- ✓ This Battery must be stored in its original carton box in a dry and cool place. DEKA DURATION carton box is marked as below:

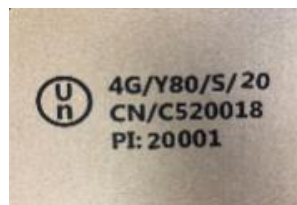

- ✓ The transportation and Storage State of Charge (SoC) shall not exceed 50%.
- ✓ The shelf period without recharging is 6 months, and then requires a quick charge up to 50% DoD. Charge at 0.1C and not more than 50% SOC. If shipped by sea, you must refer to the UN38.3 standard. If by road, refer to local codes.
- ✓ To preserve the performance and shelf life, this battery should optimally be stored at 77°F (25°F) and @70% humidity.
- ✓ Acceptable storage temperature range of the battery is between +59°F and +95°F (+15°C and +35°C).
- ✓ The self-discharge in the range of +59°F to +119°F (+15°C to +35°C) is around 1% a month. Anything outside this range could exceed 10% a month.
- ✓ Do not store the batteries near sources of heat, vapor, gas, fuels, sparks or anything that could generate fire or explosion.
- ✓ Store inside and protect from water and moisture.
- ✓ Transportation of new and used or damaged modules must be in accordance with the UN 38.3 Regulation and with the Federal, State and Local regulations.
- ✓ If one or more working Battery Modules need to be removed or relocated, they must be marked as **USED BATTERY** (follow local rules).
- ✓ If one or more Battery Modules need to be replaced due to damage, they should be marked as **DAMAGED USED BATTERY** and follow any applicable procedures and all Federal, State and Local regulations.





The installer approaching this battery model for the first time must understand the use and operation of its accessories.

The DD5300 Battery Module can be equipped with an auxiliary combiner such as:

DD21001 HUB for Low Voltage configurations up to 105 batteries (7-Clusters x 15-Modules)

DD21002 HV BOX device for High Voltage configurations up to 144 batteries (9-Clusters x 16-Modules).

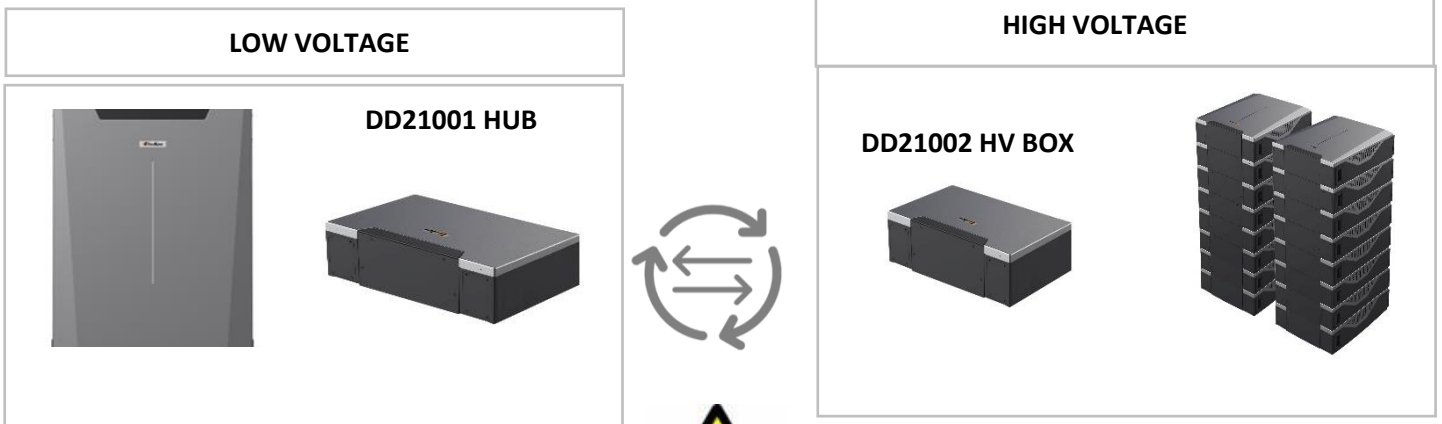

Each device or accessory of the DD5300 will have a specific Firmware that manages the logic and interconnection functions between Battery Modules and devices.

It is therefore important to understand the operational and interaction concepts of the DD5300 battery within a more complex system.

**DD5300 MODULE**

Firmware  
**20.00**

**DD21001 HUB**

Firmware  
**30.00**

**HV BOX DD21002**

Firmware  
**50.00**

## 1.2 Module Unpacking and Handling

The battery is always delivered in WALL mode, and it is therefore necessary for the installer to make simple changes to install the STACK kit. Below are the installation phases.



**ATTENTION:**

**The battery must be lifted by four persons, using the four handles.**

Two handles are built in and the other two are provided as temporary handles to be used as shown below.

Open the carton box, find the portable and retractable handles, position them and proceed with lifting.

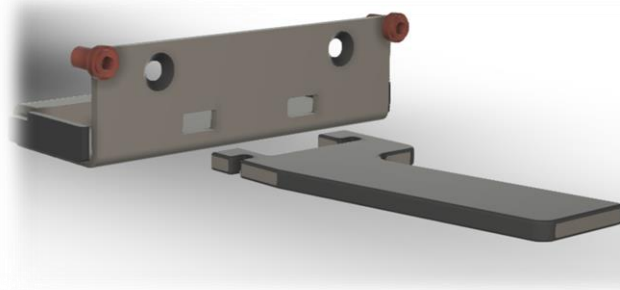
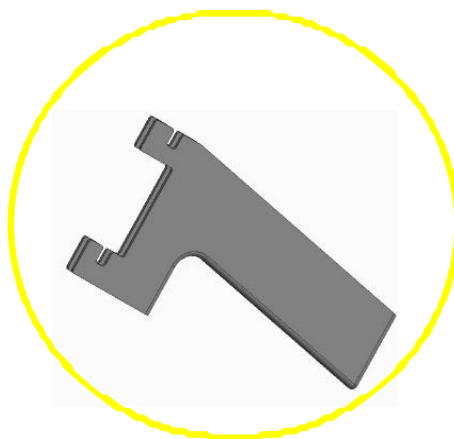
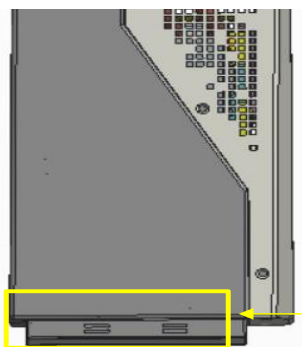

Interlock the handles inside the feet holes



### 1.2.1 Package Information and System Configuration List

The battery box is packed in cartons with accessories.

Upon receipt, review the configuration list carefully to make sure that the battery box and accessories are received in the correct quantities and type, and visually inspect to ensure that they are free from damage.

Refer to Section 2.1.3 for Low Voltage packing list and to Section 3.1.3 for High Voltage packing list. If battery is damaged and/or components missing, contact your local Deka Duration representative.

### 1.3 Wall Mount or Stack Mount Configuration



**NOTE:** The Deka Duration DD5300 Battery Module ships as standard in the wall mount configuration.

#### 1.3.1 Battery Dimensions\* (Wall Bracket)

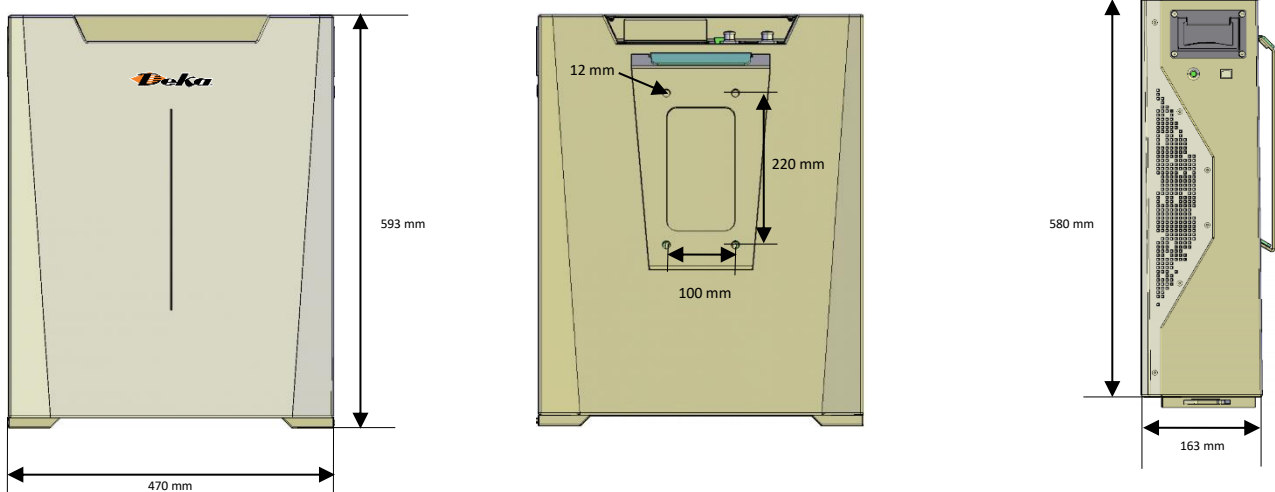

\*Dimensions are subject to construction tolerance +/- 1%

#### 1.3.2 Wall Mount

**Step 1:** Install the wall bracket by using the wall plugs and screws contained in the battery kit.

The wall must be inspected before proceeding with the bracket installation. A local civil engineer should assess the correct installation method, either wall mounted or floor mounted.





**ATTENTION:**

The Battery Module weighs 126.3 lb (57.3 kg) and must be installed with the help of a mechanical lift, and/or with at least two people equipped with suitable suction cups for mechanical lifting or lifting straps.

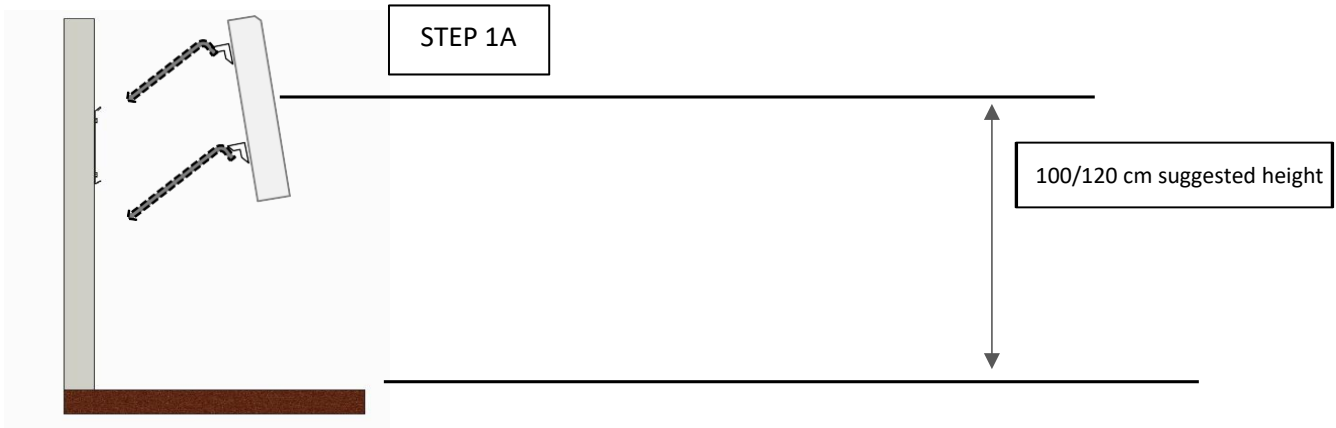

The Bracket must be installed on a flat and vertical wall.

The steel bracket must be flush to the wall without any empty spaces between the wall surface and the back side of the bracket. Make sure to have adequate space to install the battery before proceeding with the installation.

**Step 2:** Install the battery by fitting the back bracket of the module with the wall bracket interlocking.

This operation must be conducted with a mechanical lifting device and/or with at least two specialized installers. Make sure the Battery Module is stable and properly locked into the upper interlocking plug.

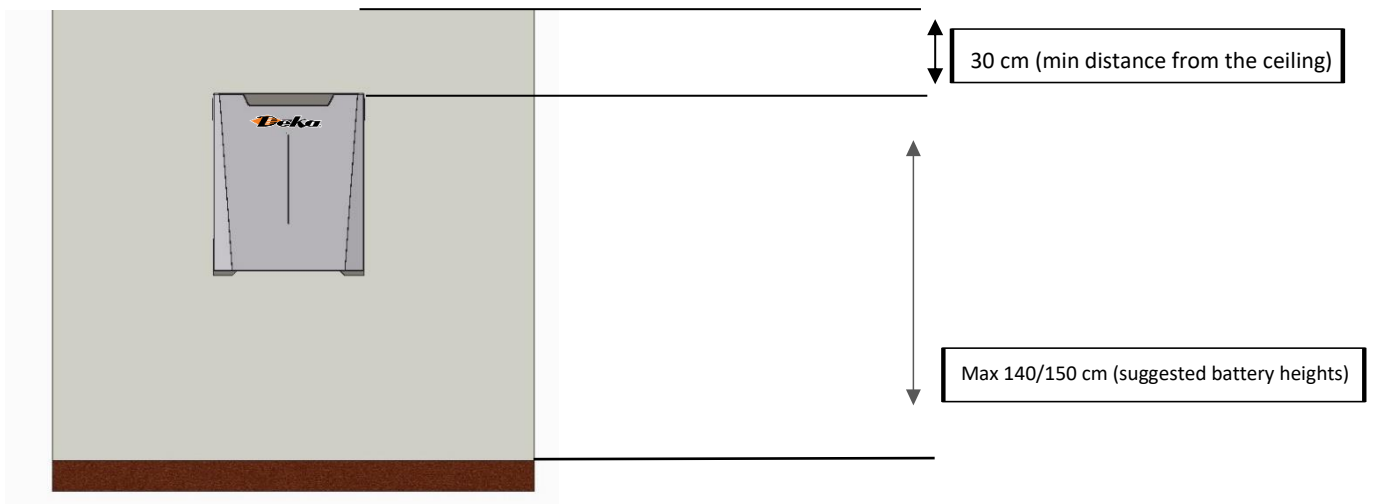

Step 2A: In case of multiple module installation, make sure to respect the distance between the modules and the ceiling.

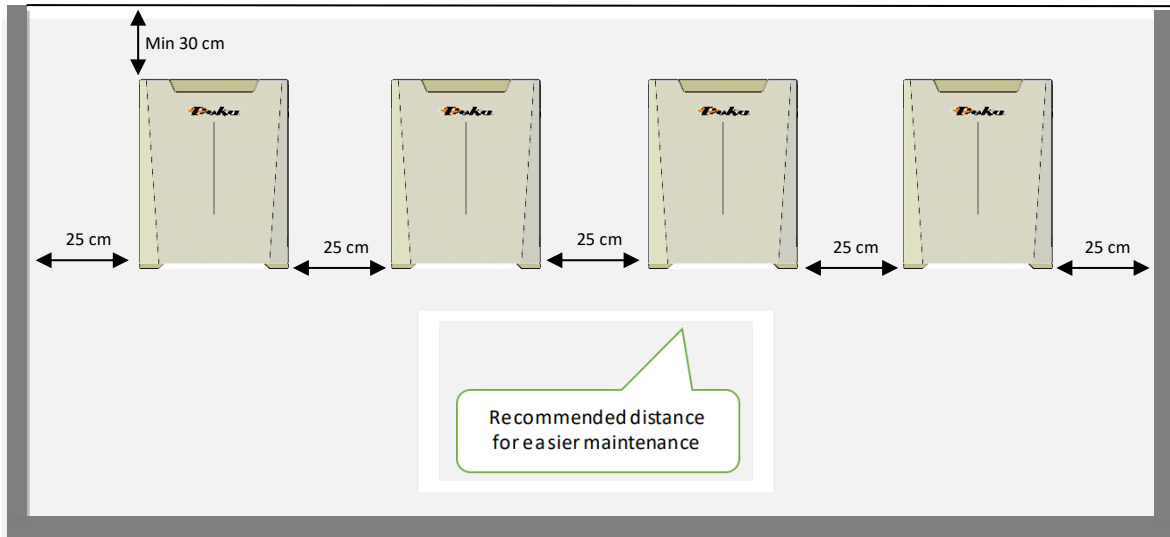

Example of a Floor or Wall Mounted battery cluster connected with power cables and data cables.

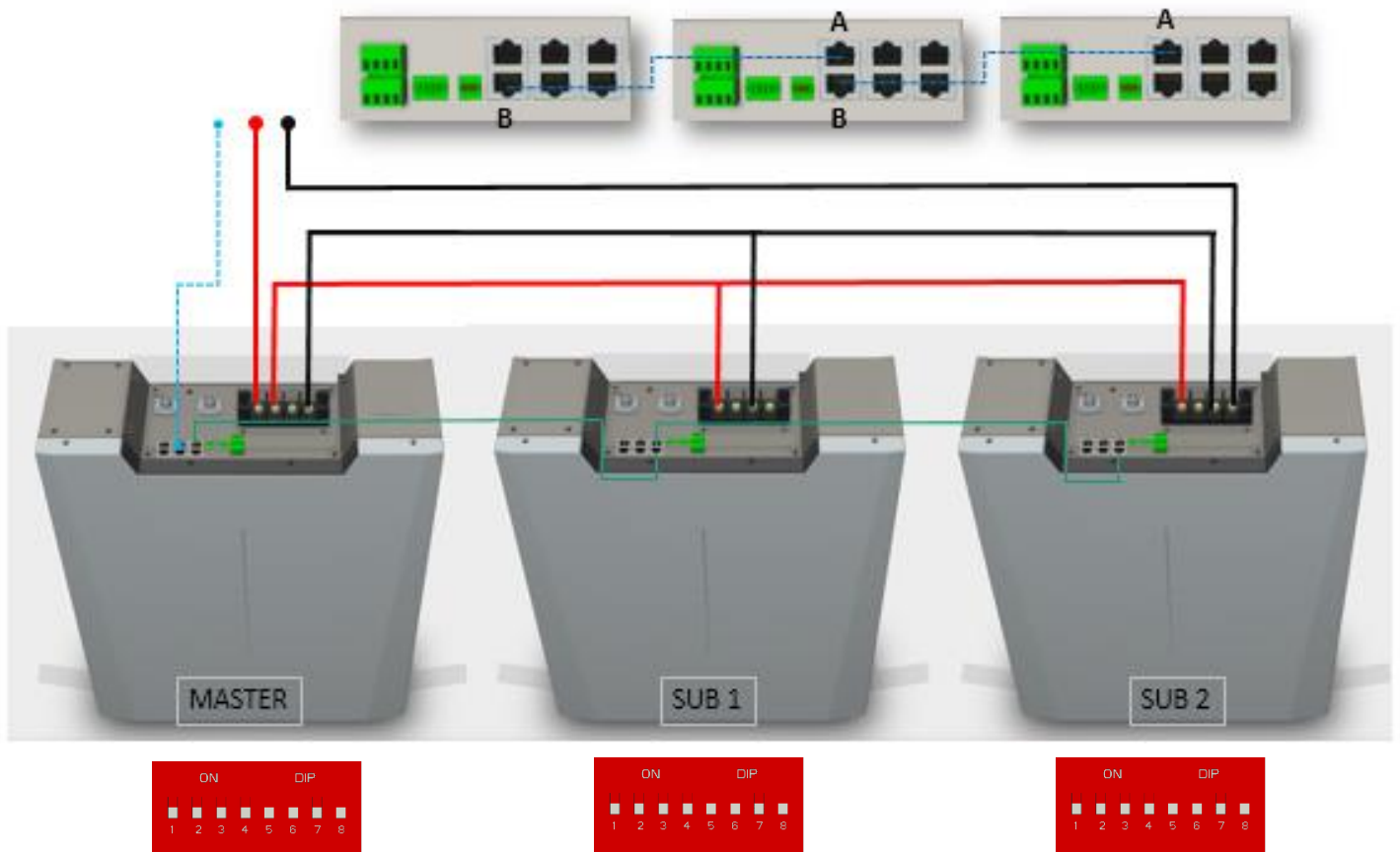

*Note: In a single cluster configuration, there is no need to set the DIP switch on the master battery. All DIP switches should be set to OFF. The single cluster will self-configure.*

Examples of a Floor or Wall Mounted battery cluster.

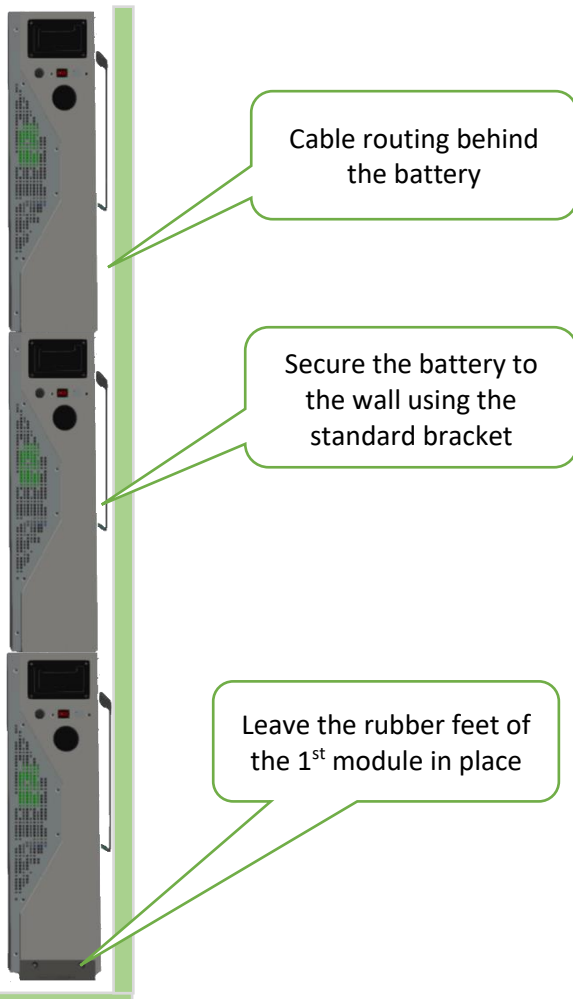

### 1.3.3 Stack Mount



**ATTENTION:**

The Battery Module weighs 126.3 lb (57.3 kg) and must be installed with the help of a mechanical lift, and/or with at least two people equipped with suitable suction cups for mechanical lifting or lifting straps.

As previously stated in this manual, the DD5300 Battery Module comes as standard in wall mount configuration.

To install in the **Stackable** configuration, the screws on the back of the battery module must be removed.

1. Remove the back-side wall support plate using an Allen Key. The plate has five screws.

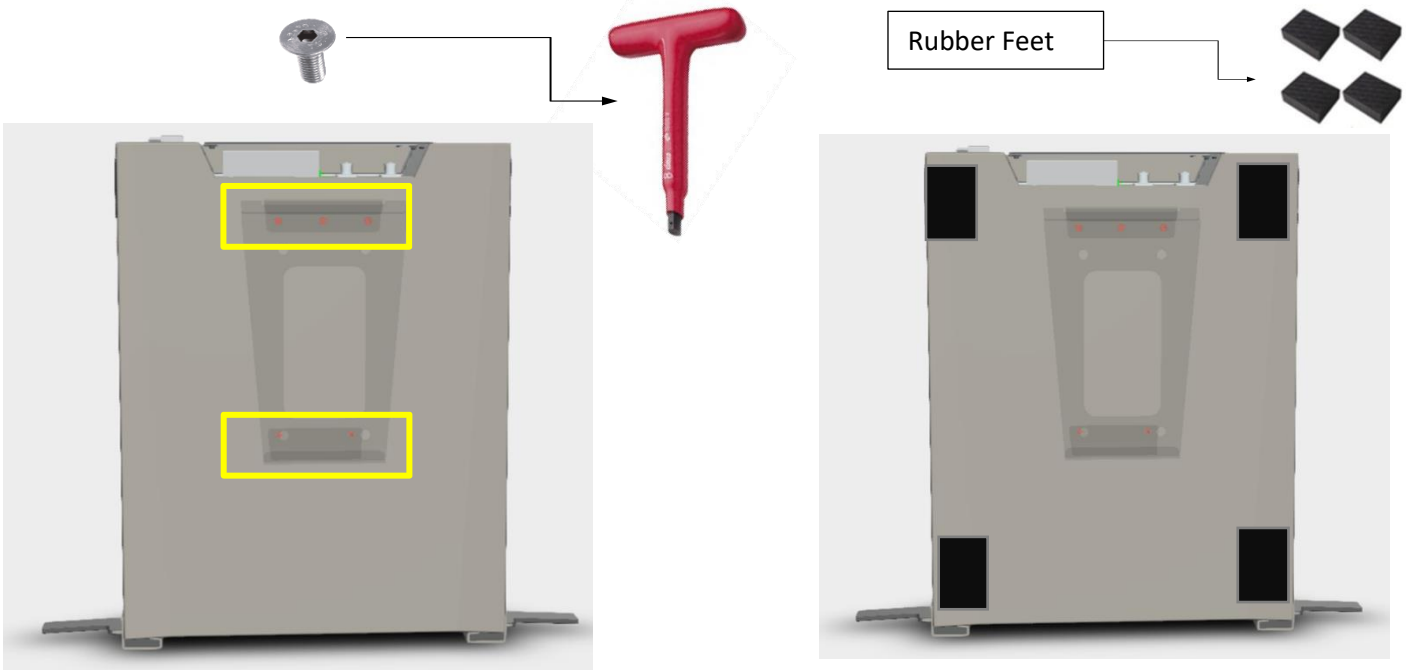

2. Once the wall bracket support has been removed, start stacking the second module on top of the first module laid on the ground by using the front retractable handles.

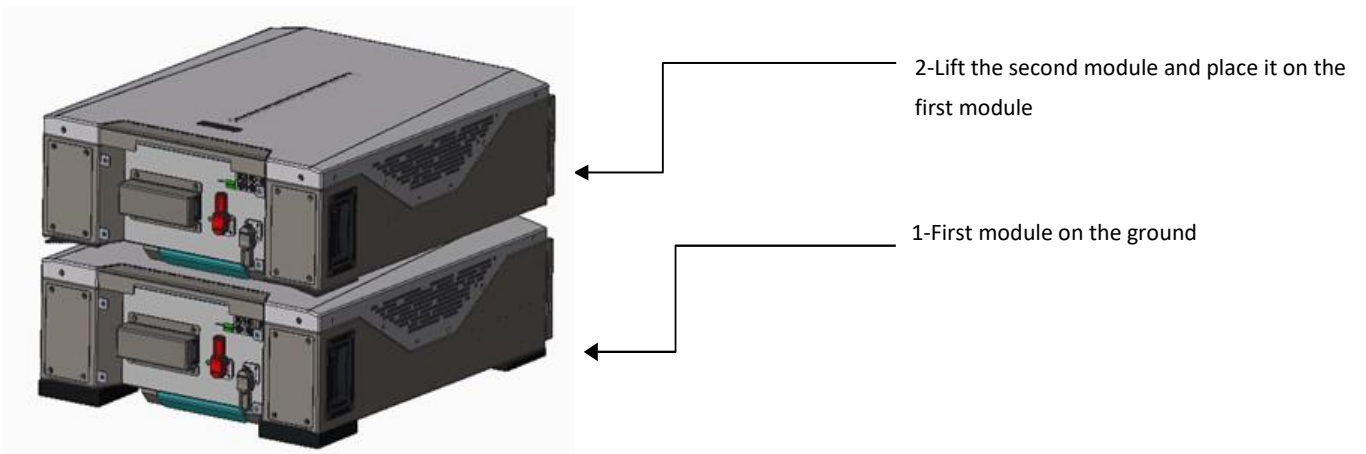



**ATTENTION:**

Before stacking the batteries, the installer must check the maximum permissible floor load. It is recommended that the installer obtains approval from a civil engineer.

For vertical ground mounting, the support surface of the Battery Module is distributed on 4 insulated supports (rubber pads), 10 x 4 cm each. Make sure to install a distribution plate or make a proper foundation to support the weight.

In case of horizontal installation, the installer must prepare an adequate distribution plate on the floor in order to make a safe and stable support for the battery stack.



**ATTENTION:**

Ensure the support and/or the floor surface is adequate to support the battery load. Do not stack more than eight modules.

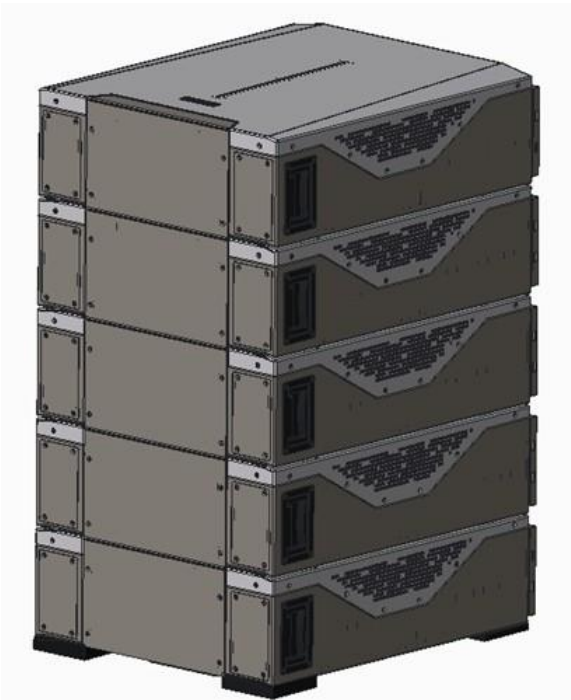

631.5 lb (286.5 kg)



505.2 lb (229.2 kg)



378.9 lb (171.9 kg)



252.6 lb (114.6 kg)



126.3 lb (57.3 kg)

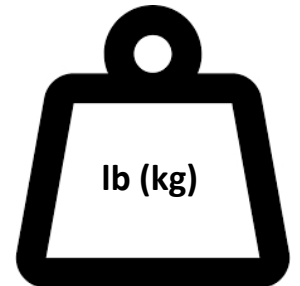



### 1.4 Battery Terminal Function Definition

The terminal layout is shown in the following figure:

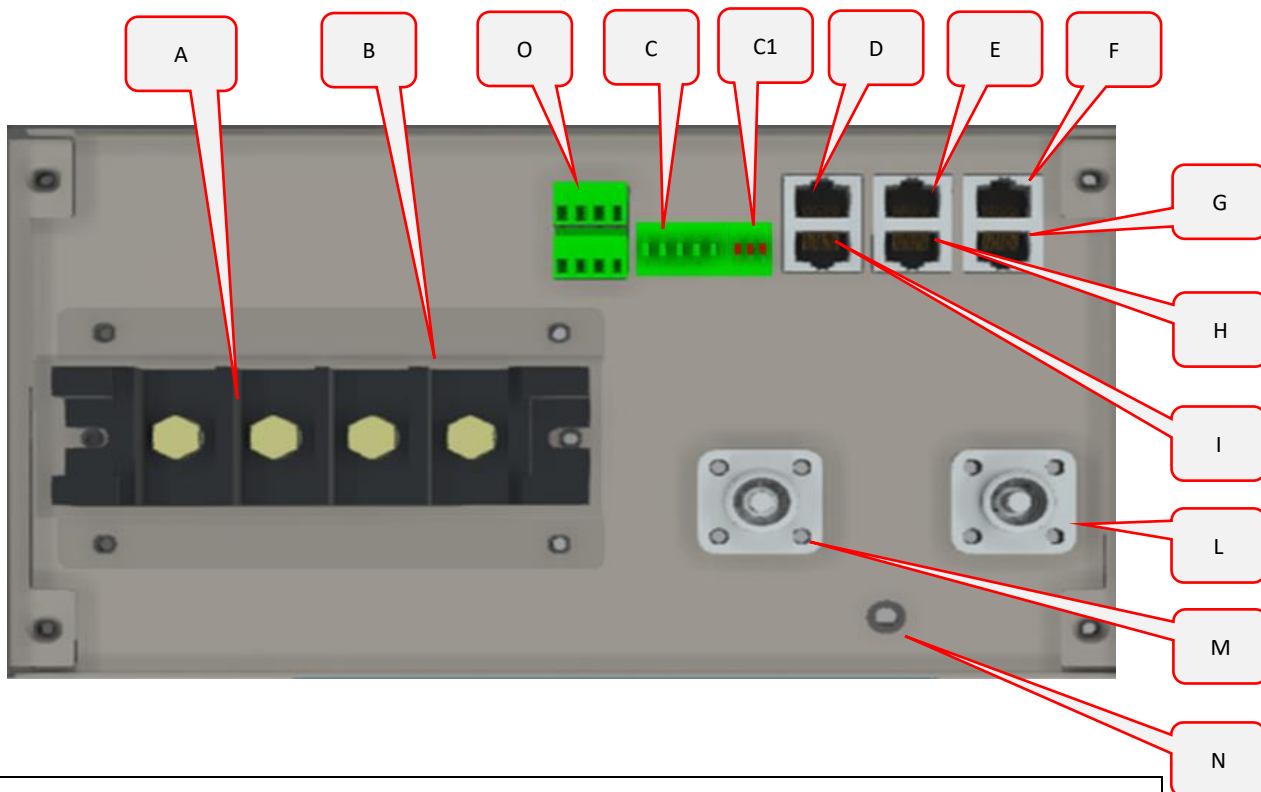

Interface	Name	Function
A	LV POLE +	LOW VOLTAGE POSITIVE (+) Screw Terminal
B	LV POLE -	LOW VOLTAGE NEGATIVE (-) Screw Terminal
C	DIP SWITCH	DIP SWITCH Address HUB 5 PINS
C1	DIP SWITCH	DIP SWITCH Termination 3 PINS (120 Ohms)
D	RS485 A LV	LOW VOLTAGE COMMUNICATION PORT RS485
E	CAN A	CAN – BMS to LOW VOLTAGE INVERTER
F	LINK	Digital Input
G	LINK	Digital Output
H	CAN B	HIGH VOLTAGE SERIAL IDENTIFIER RJ45 CAN PORT
I	RS485 LV	LOW VOLTAGE COMMUNICATION PORT RS485
L	HV POLE -	HIGH VOLTAGE NEGATIVE (-) Fast Connector Terminal for serial connection
M	HV POLE +	HIGH VOLTAGE POSITIVE (+) Fast Connector Terminal for serial connection
N	GND	Ground Terminal
O	DRY CONTACTS	Dry Contacts Terminal

**Attention:** Interface E: RJ45 port corresponding to the CAN bus pin definition

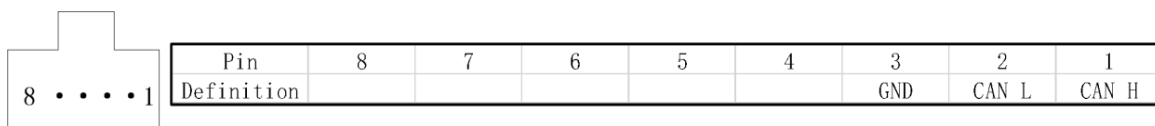

## 1.5 Out of the Box Pre-Operational Check

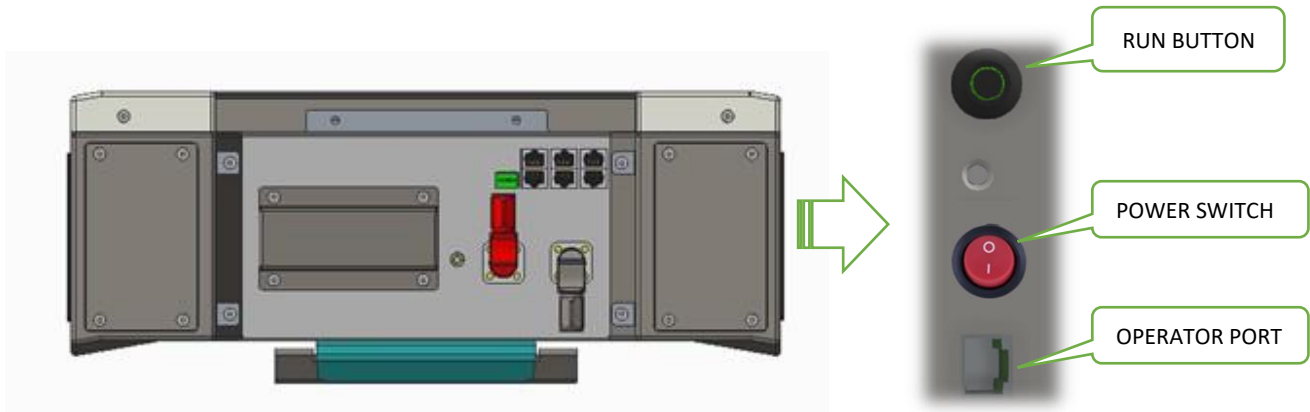

**Attention:** Do not make any connection to the Battery Module until you have thoroughly read and understood this entire manual.

The Run Button and the Power Switch are located on the right side of the Battery Module as shown above. The Power Switch is a RED mechanical ON/OFF switch that enables/disables the power supply of the BMS. Set the Power Switch to ON (1) to start activation of the battery power supply, Set to OFF (0) to shut down completely.

The Run Button is a GREEN LED button that when pressed for 2 seconds will initiate the startup process of the battery.

Pressing the Run Button for 5 seconds will shut down the battery (the BMS will remain powered).

The Run Button will settle as a steady GREEN color if the battery is operating correctly. If the battery is low on charge, the Run Button will blink GREEN.

If the front LED bar displays a flashing RED LED in conjunction with the other LED colors, the fault should automatically clear within 4 minutes after a restart. In any case, it is required to inspect the system settings before attempting a new restart, following the steps in the manual.

If the LED bar is all illuminated in RED, there is a major fault and you should not attempt any further operation of the battery. Contact Deka Duration support at [durationsupport@dekabatteries.com](mailto:durationsupport@dekabatteries.com).

There is an RS232 Operator Port which will allow you to check all parameters of the Battery Module. Full instructions on how to interface to the RS232 port can be found in this manual.

### ATTENTION:

Before operating make sure that the voltage is equal to **0 Vdc**  
Battery must be turned off before starting any activity

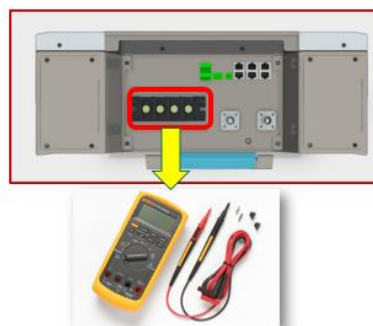

**Attention:** At this stage, after you have determined that the battery is functioning correctly, it is mandatory to switch the battery off and follow the instructions and guidance in this manual very carefully before attempting any configuration or connection to the Battery Module.

To switch the battery off (shutdown the battery), simply press the Run Button for 5-seconds and the GREEN LED light will go off, confirming that the Battery Module has shutdown correctly.



**Attention:** Read this manual thoroughly, and always follow the guidance herein before and while performing any installation procedure.

## SECTION 2 - LOW VOLTAGE CONFIGURATION

### 2.1 Product Introduction

The Deka Duration DD5300 Battery Modules can be used as an on-grid or off-grid energy storage system. It is not recommended to use this product for any purpose other than the intended purpose as described in this document.

Use of this product other than as described in this document will nullify the product warranty. The substitution of any components of this Battery Module will nullify the product warranty.

The use of any components contained within or connected to this Battery Module other than the products sold as part of this product or recommended by the manufacturer will nullify the product warranty.

Connecting more than eight Deka Duration DD5300 Battery Modules in parallel will nullify the product warranty.

#### 2.1.1 Identifying the Individual Module

Dimensions	mm	593x470x163
Weight	lb (kg)	126.3 lb (57.3 kg)
Case Material	Type	Steel
Parallel Modules	Max No.	15
Stackable	Type	Yes
Digital Output	No.	2+2
Cell Distribution	P/S	16S



*\*Other variables can be introduced by the BMS*

Cell type	Type	LiFePO4
BMS Charge Temp	°F (°C)	+19.4°F to +131°F* (-7°C to +55°C*)
BMS Discharge Temp	°F (°C)	+131°F to -4°F* (+55°C to -20°C*)
Suggested Storage Temp	°F (°C)	+77°F (+25°C) (shelf life 1 year)
Storage Temp/Time outside the suggested storage temperature	°F (°C)	-13°F to +131°F / 4 months (-25°C to +55°C / 4 months)
Self-Discharge @ 77°F (25°C)	%	1% per month
Self-Discharge outside the STC	%	< 3% per month

## Product Identification and labels

The nameplate label describes the product parameters and is attached to the product. For details, please refer to the nameplate label of the product. For safety reasons, the installer must have a thorough understanding of the contents of this manual before installing the product.

### DEKA DURATION BATTERY MODULE – PRODUCT LABEL

 <span style="float: right;">Energy Storage System</span>	
East Penn Manufacturing Co.	
Emergency Numbers	USA/Canada: CHEMTREC (800) 424-9300 Outside USA: 1 (703) 527-3887 MK Battery: (714) 937-1033
Model Type	DD5300
Nominal Capacity @ Standard Test Conditions	100Ah
Cell Type (Chemistry)	LiFePO <sub>4</sub> (Lithium Iron Phosphate)
Nominal Voltage	52 Vdc
Max BMS Protection Voltage	58.4 Vdc
Min BMS Protection Voltage	46.5 Vdc
Charging (-) Discharging (+) BMS Current	-100 A / +100 A (peak +200 A for 5 sec.)
Maximum Short Current (A) and Time (µs)	1500A / 500µs
Parallel Units (from LV terminals)	15 Units (follow the parallel procedure)
Serial Units (from HV terminals)	16 Units (follow serial connection procedure)
IP Grade	IP21
Standards*	EMC (EN61000-6-3:2007/A1:2011/AC:2012) IEC 61000-3-2:2014 IEC 61000-3-3:2013 IEC 61000-3-1:2007 IEC 62619 UL 1973
Good Class	Dangerous Goods DG9 Category 3480
UN Class	UN 38.3 Lithium Ion Battery
Production Date	
<p>This product must be installed and maintained by qualified professional installers. Read warranty terms and conditions before use. Improper use and installation will void the warranty.</p> <p> Lire les modalités de la garantie avant l'utilisation. La garantie sera annulée si le produit n'est pas installé et utilisé de la bonne façon. Ce produit ne doit être installé et entretenu que par des installateurs qualifiés.</p> <p>Lea los Términos y condiciones de la garantía antes de instalar. Uso e instalación inadecuados anulará la garantía. Este producto debe ser instalado por personal altamente calificado igualmente prestar servicio.</p>	
	
<p>*DD5300 is identical to model 5K3-XP produced by WeCo. WeCo SGS Contract No. 801492.</p>	

L  
O  
W  
V  
O  
L  
T  
A  
G  
E









### 2.1.2 Accessory List (Standard Kit 120A Single Module LV)

The Battery Module is packed in a carton together with standard accessories. When unpacking the Battery Module, be sure to check that the Battery Module and accessories are free from damage and that the correct quantities of each component are included within the carton.

The following list of components can be used as a checklist when unpacking the individual Battery Module and battery kits.

Cable Diameter	Cable Color	Cable Length	Description	Quantity	Picture
25mm	BLACK	250 cm	Both sides ring terminal diam 8mm for LV connection <b>Required for LV Installation</b>	2	
25mm	RED	250 cm	Both sides ring terminal diam 8mm for LV connection <b>Required for LV Installation</b>	2	
CAT 5	BLUE	120 cm	RJ 45 RJ 9 BMS to Inverter CAN <b>Required for LV Installation</b>	1	
CAT 5	BLUE	120 cm	RJ 45 RJ 45 LV PARALLEL CABLE <b>Required for LV Installation</b>	1	
Wall Bracket			Wall Plate for Battery Support + 4 M10 Wall Plugs + Screws		
Removable Brackets			Set of 2 back brackets with M6 screws (Allen Key) for wall installation	set	
Lifting Handles			2 X Lifting Handles	1 Set	
Insulated Rubber Support Pads w/ Adhesive			4 X Each Module	4	

### 2.1.3 Necessary Installation Tools

 <p>Multimeter + Current clamp</p>	 <p>Insulated Screwdriver Set</p>	 <p>Insulated Allen Key Set from 2 mm to 8 mm</p>	 <p>Drill + Hammer</p>
 <p>Electrician Scissors</p>	 <p>Insulated Torque Wrench Set</p>	 <p>Lifting Strap + Mechanical Lifter</p>	 <p>RS232/USB + Screw Terminal (insulated)</p>

### 2.1.4 Personal Protective Equipment +1000 Vdc Insulated Tools



L  
O  
W  
  
V  
O  
L  
T  
A  
G  
E

## 2.2 Low Voltage Module Wiring and Set Up

### 2.2.1 Battery Connection Terminals

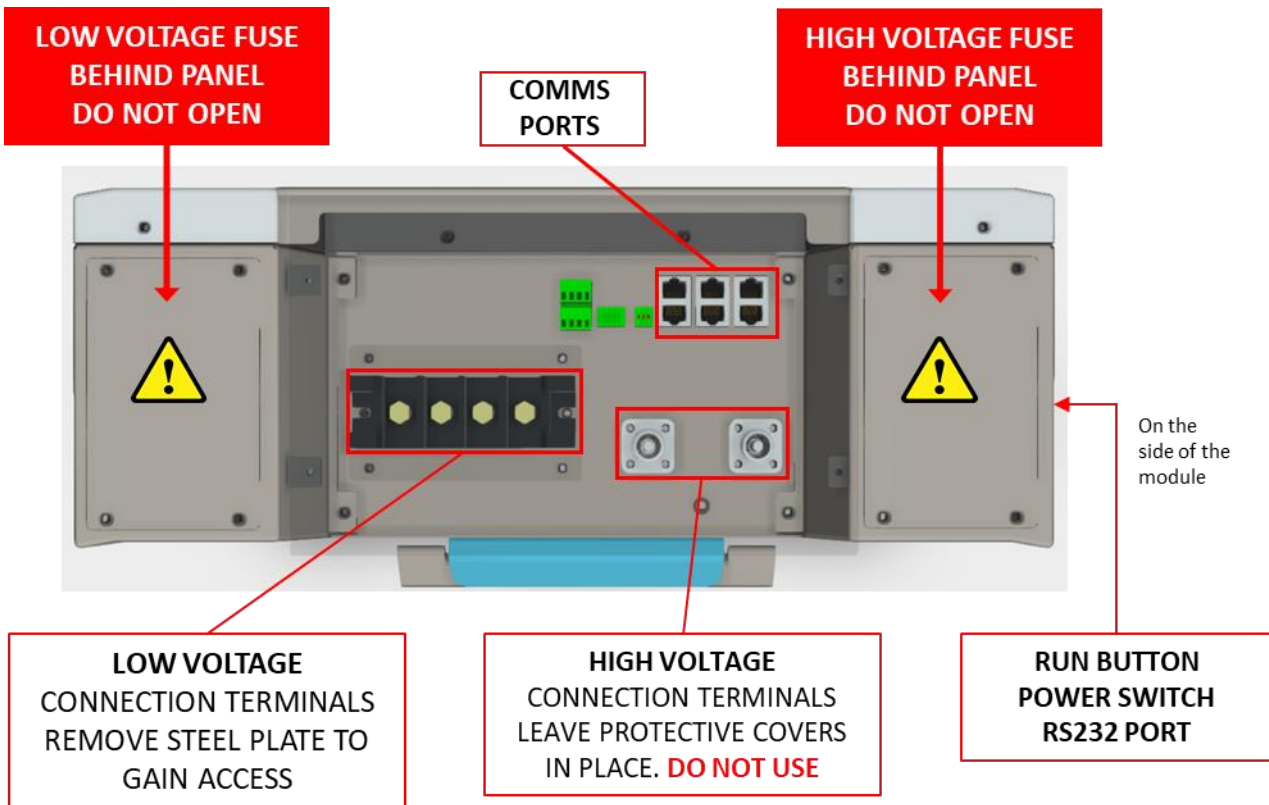

**CAUTION:** The LV fuse is contained in the left portion of the Battery Module as shown above. The access to the fuse is restricted to authorized Deka Duration service personnel and the protection lid cannot be opened by anyone else. The same applies to the HV fuse.

### 2.2.2 BATTERY CAN Pin Out

The terminal layout is shown in the following figure:

8 . . . . . 1	Pin	8	7	6	5	4	3	2	1
	Definition						GND	CAN L	CAN H



## 2.3 Low Voltage DIP Switch Settings



### ATTENTION:



ALWAYS CONFIGURE THE DIP SWITCH SETTINGS BEFORE CONNECTING ANY POWER CABLES TO THE BATTERY TERMINALS B+ AND B-.



WHEN CHANGES HAVE BEEN MADE TO DIP SWITCH SETTINGS, THE BATTERIES MUST ALWAYS BE RESTARTED FOR THE CHANGES TO TAKE EFFECT.



POWER CABLE CONNECTIONS MUST BE MADE IN STRICT ACCORDANCE WITH THE INSTRUCTIONS IN THIS MANUAL. INCORRECT POWER CONNECTIONS CAN DAMAGE THE BATTERY MODULE AND CAUSE INJURIES.



WHEN THE INVERTER HAS A CANBUS COMMUNICATION PORT, SWITCH #7 OF THE MASTER BATTERY MUST ALWAYS BE SET TO "ON."



**Attention:** All drawings are for reference only. Always refer to the physical product as the standard. If the manual does not match the physical product, stop all actions, remove any connections, and store the batteries in a safe place. Call your Deka Duration technical service representative for assistance.



### 2.3.1 LOW VOLTAGE PARALLEL CONFIGURATION

The DIP switch must be set as follows to allow a single Battery Module to communicate with an inverter using CAN communications:



**WHEN THE INVERTER HAS A CANBUS COMMUNICATION PORT, SWITCH #7 OF THE MASTER BATTERY MUST ALWAYS BE SET TO “ON.”**

#### DIP CONFIGURATION UP TO FIFTEEN MODULES IN PARALLEL

**From the 1<sup>st</sup> to the last module (or 15<sup>th</sup>) for a SINGLE CLUSTER in Low Voltage Configuration, the DIP setting of each battery must be set as per the picture below:**

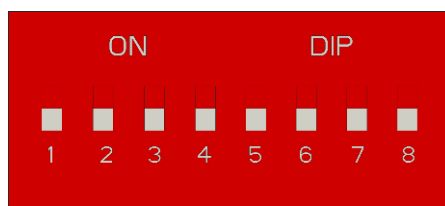

**For Single Cluster Parallel Configuration\***

*\*DIP Switch settings for multiple clusters are covered in a separate section of this manual.*

### 2.3.2 LED Visual Indication Lights

There are three sources of visual indications on the Battery Module:

- POWER SWITCH ON/OFF
- RUN BUTTON GREEN LED
- FRONT LED BAR Multi Color

## 2.4 Module Activation and Shutdown

### START UP PROCEDURE

The Power Switch and Run Button are located to the right of the battery terminal connections on the side of the battery chassis. The Power Switch is a mechanical switch that switches the battery ON or OFF. The Run Button is an LED button that is only enabled when the Power Switch is in the ON (1) position. The Run Button provides several status indications that are described in the table below.



Name	Meaning	Function or Indication Status
POWER SWITCH	On/Off Button	Switches the Battery Module on and off.
RUN BUTTON	Module Correct Operation	When the Battery Module is running normally, indicator light will be STEADY GREEN.
LOW BATTERY	Low SOC	When the battery SoC is low (SoC<0-5%) the RUN Button will blink in a GREEN color at 1 second intervals. The RUN Button will stop blinking and turn STEADY GREEN when the battery is in charging mode and the SoC reaches 10%.
FRONT LED BAR	Fault indicator light (See Section 2.5.5)	When there is a fault with the Battery, the front LED BAR will show a full RED LED LIGHT and the RUN BUTTON will show no light within 10 seconds from the event.

**POWER ON:** Turn ON the Power Switch (1 = ON 0= OFF)

A 2-second press on the Run Button will turn the Battery Module on.

During the startup procedure, the Run button will blink until the safety inspection has been completed by the BMS.

**SHUTDOWN:** A 5-second press and hold on the Run Button will turn the Battery Module off.

Turn OFF the Power Switch ( 1 = ON 0= OFF)

Other functions of the Run Button are explained in the relevant sections of this manual.



**Attention:** Read this entire manual thoroughly to understand the correct startup and shutdown procedures for each battery configuration.

**POWER SWITCH**

For a complete shutdown of the Battery Module press the Run Button for 5 seconds and then set the Power Switch to the OFF (0) position.



**CAUTION:** After setting the DIP switch, the Battery Module must be restarted for the DIP switch changes to take effect.

**ATTENTION:**



**ALWAYS CONFIGURE THE DIP SWITCH SETTINGS IN ACCORDANCE WITH THIS MANUAL BEFORE CONNECTING ANY POWER CABLES TO THE BATTERY TERMINALS B+ AND B-.**



**WHEN CHANGES HAVE BEEN MADE TO THE DIP SWITCH SETTINGS, THE BATTERIES MUST ALWAYS BE RESTARTED FOR THE CHANGES TO TAKE EFFECT.**



**POWER CABLE CONNECTIONS MUST BE MADE IN STRICT ACCORDANCE WITH THE INSTRUCTIONS IN THIS MANUAL. INCORRECT POWER CONNECTIONS CAN DAMAGE THE BATTERY MODULE AND CAUSE INJURIES.**



**WHEN THE INVERTER HAS A CANBUS COMMUNICATION PORT, SWITCH #7 OF THE MASTER BATTERY MUST ALWAYS BE SET TO "ON."**



**Attention:** All drawings are for reference only. Always refer to the physical product as the standard. If the manual does not match the physical product, stop all actions, remove any connections, and store the batteries in a safe place. Call your Deka Duration technical service representative for assistance.

## 2.5 Low Voltage Parallel Set Up Overview

DD5300 can be connected in parallel up to 15 modules, this process requires a full knowledge of the product.

### DIP Configuration for LOW Voltage Parallel



#### CAUTION:

For a single cluster installation, it is necessary that the DIP switches of **all the batteries** are set as below. All switches are set to "OFF"



**After setting the DIP Switch, the Battery Module must be restarted for the DIP switch changes to take effect.**

- Once the DIP Switches of the single cluster have been set, it will be possible to perform the connection of the earth terminal between the modules and the general earth rod, and subsequently it will be possible to connect the RS485 B Port of the Master battery with the RS 485A Port of the SUB-1 battery using the RJ45 cable supplied.
- Continue to connect the RS485 ports in sequence up to the last module.
- Set the Power Switches on all batteries to the ON (1) position.
- Press the RUN BUTTON of the MASTER ONLY to initiate the cluster automatic start up. There is NO NEED to press any of the Sub Module Run Buttons as they will be configured automatically when the Master Run Button is pressed.
- Wait until the Run Buttons on all modules are a STEADY GREEN.

Finally, it will be possible to proceed with the power connections using the BUS BAR (accessory) if you are installing in stackable mode or, if the installation is wall or floor mounted, you can use battery cables properly sized according to the distance between the modules.

The connection between the INVERTER and the MASTER / LAST MODULE must be performed using cables.

(If you need to connect more than 5 modules in parallel it is necessary to create more towers composed of 5 modules, and connect them in parallel with each other via cables).

See Example on the next page.

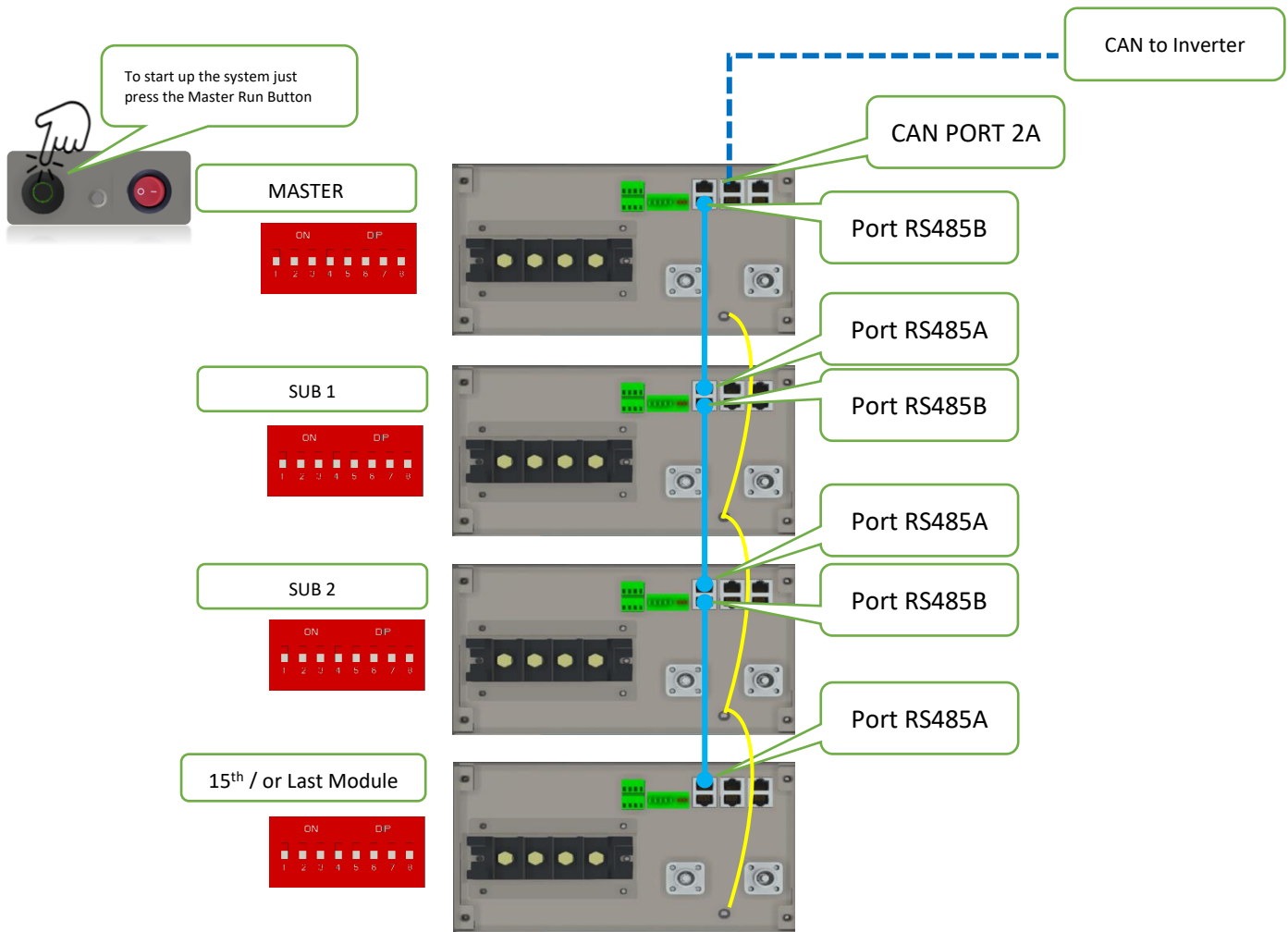

### 2.5.1 Auto ID Assignment and DIP Configuration for LOW Voltage Single Cluster (Parallel Connection)

#### STEP 1

#### ACTIVATING THE BMS FROM THE POWER SWITCH

It will be necessary to activate all the batteries by switching on the POWER SWITCH ( ON= position 1)

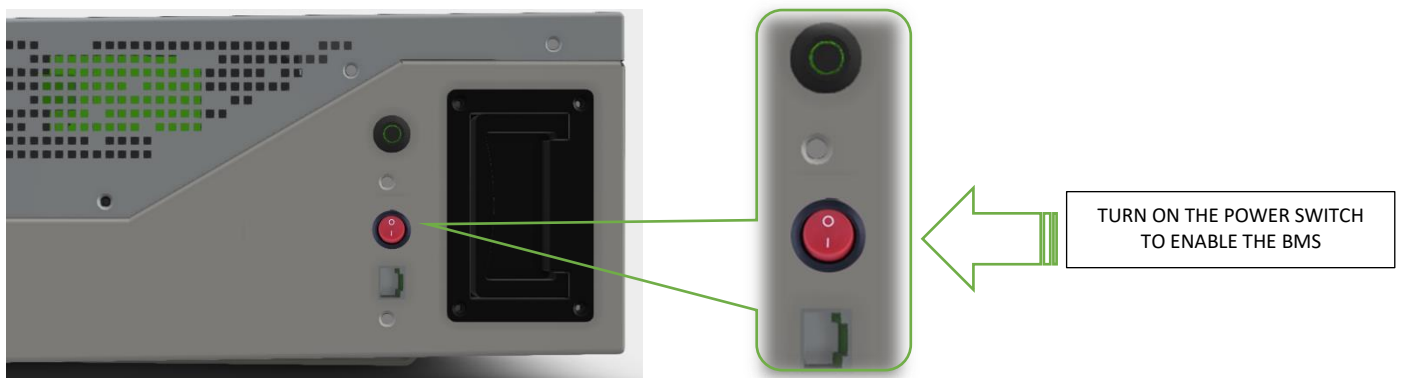

**STEP 2**

**AUTO WAKE-UP PROCESS (Pressing the RUN BUTTON )**

Once all the connections have been checked, it is possible to start the Battery Module by enabling the automatic wake-up process.

Press the RUN button of the MASTER battery, the RUN BUTTON will Blink and will wake-up all the SUB batteries connected.

This process might take around 2-3 seconds per battery (Do not turn on the SUB manually as the automatic process will assign a battery ID in sequence).

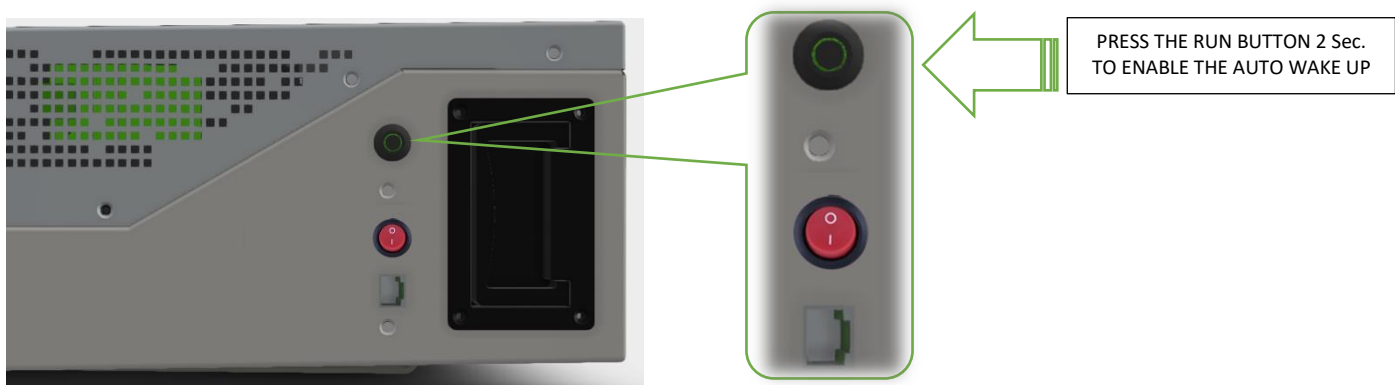

It is essential to check the startup progression and make sure that all LEDs of the RUN BUTTON are ON and showing steady GREEN lights after the wake-up process (the entire process might take up to 30-45 seconds in case of 15 batteries).

During the startup process, all the RUN BUTTONS will blink until the last module sends the final consent to the MASTER to enable the contactors.

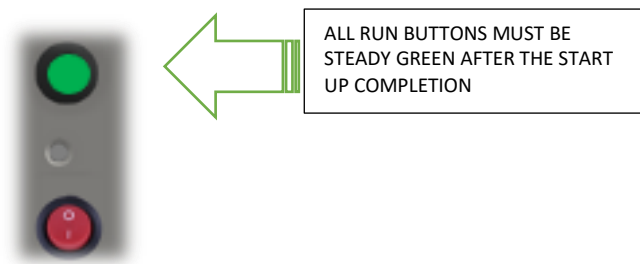

If during the process, one or more Battery Modules will not turn ON or if the LED does not become steady, it is mandatory to switch off the MASTER and check all the connections between PORTS RS485B and A.

Make sure to turn ON and OFF every Battery Module after setting up the DIP switches.

Make sure all the Battery Modules remain active after the first cycle of charge and discharge.

In case of any anomaly during this process, it is necessary to shut down the entire cluster and repeat the procedure from STEP 1.

**ATTENTION: All the SUB MODULES will automatically shut down after 60 seconds from the moment that the master is OFFLINE.**

**To completely turn off the cluster, it is compulsory to switch OFF all the POWER SWITCHES of each module.**

### 2.5.2 Single Cluster DIP and DATA Connection

The DIP SWITCH setting for the SINGLE CLUSTER LV mode has an automatic function that assigns the single module ID in cascade. It is mandatory to connect each module in Daisy Chain connection starting from the RS485B PORT of the master unit.

The DIP sequence for the LV single cluster must be



on every module that composes the cluster.

**PRESS RUN BUTTON**  
Only on the 1<sup>st</sup> Module

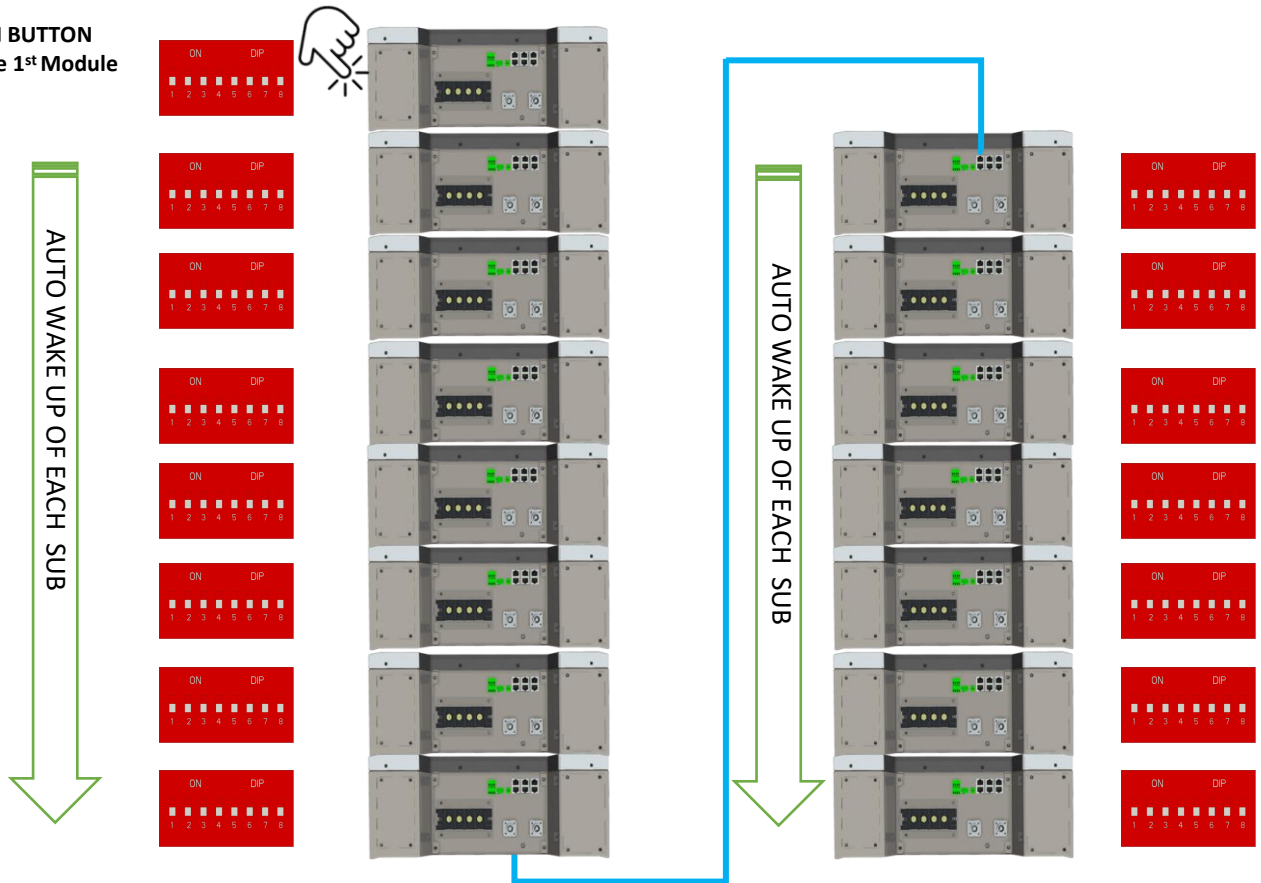

### 2.5.3 Parallel Battery Wiring Connections



**ATTENTION:**

POWER CABLE CONNECTIONS MUST BE MADE IN STRICT ACCORDANCE WITH THE INSTRUCTIONS IN THIS MANUAL. INCORRECT POWER CONNECTIONS CAN DAMAGE THE BATTERY MODULE AND CAUSE INJURIES.



# 14 Nm (10.33 ft lb)

## Battery Terminal Block Power Cable Tightness

**CHECK TORQUE EVERY THREE MONTHS**



**Attention:** Screws, Cables and Bus Bar POWER CONNECTIONS on the battery terminal block must be installed with due diligence, and the tightening of the connection terminal must be to 14 Nm (10.33 ft lb). Each terminal should be inspected, and its torque checked every three months.



**Attention:** All drawings are for reference only. Always refer to the physical product as the standard. If the manual does not match the physical product, stop all actions, remove any connections, store the batteries in a safe place and call your Deka Duration technical representative for assistance.



**Attention:** For the power cable connection for high current, please refer to the specific section to see the diagram. Charging current limitation is mandatory as per this instruction manual.

Screw Diameter (ISO) Code	Max Fixing Torque [Nm]	Application	Construction Applied Torque [Nm]
M3	1.7	BMS protection Cover	1,2
M4	3.8	External Covers	3
M5	7.5	Isolators and Contactor Supports	7
M6	13	Fuses, Cables and Cable Lungs Connection to Terminals /Feet /Brackets/ Wall Plugs	10
M8	14	Plastic to steel and Cables on Terminal Block / Feet / Brackets / Wall plugs	14
M8	32	Steel on Steel Connection / Steel to copper/ Contactor terminal to Bus bar)	16
M10	62	External Bus Bar ( Aluminium and Copper) steel on steel connection	40
M12	107	External connections, copper to copper joints	80



**ATTENTION**

If during the quarterly check the screws will have residual torque lower than these values, it means that the cables and the busbar are subjected to out-of-range currents and the thermal effect is loosening the screws / bolts

L  
O  
W  
  
V  
O  
L  
T  
A  
G  
E

### 2.5.4 Low Voltage Single Stack Power and Data Connections (15-Modules Maximum)

Proceed with the physical installation of the desired quantity and configuration of the Battery Modules, following the installation sequences and guidelines as described in Section 1 and Section 2 of this manual.

Connect the power cables as indicated below, making sure that the batteries are OFF (check the button LED on the bottom) and always measure the terminals with a multimeter to check for **ZERO VOLTS**.

As per UL regulation, a circuit breaker is compulsory to separate the battery circuit from the inverter.

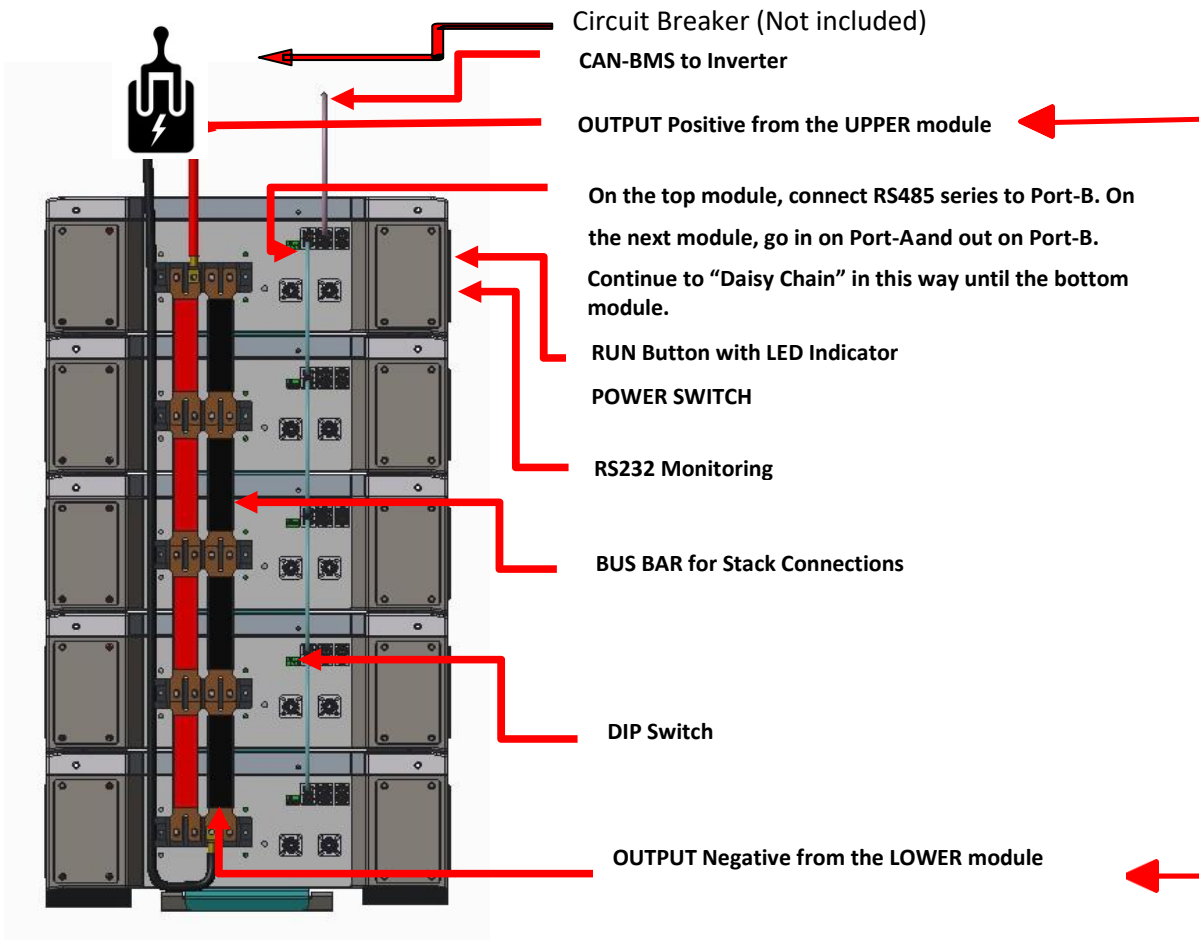

**Information:** When multiple Battery Modules are connected together, it is possible to choose between “capacity” chain series or parallel to increase capacity and peak. In case of parallel, the parallel battery and inverter can only communicate through CAN interface, and the communication between the batteries will be through RS485.



**Attention:** Be sure to follow the above method of “Daisy Chaining” the RS485 connections, starting at Port-B on the upper Battery Module, then into Port-A on the next module and out of Port-B, then into Port-B on the next module, and so on.



**Caution:** **B+** interface is always positive, **B-** interface is always negative; GND is for the parallel battery grounding Port.

L  
O  
W  
V  
O  
L  
T  
A  
G  
E





**Information:** Connect the cables according to the installation requirements, always paying attention to minimize the length of the cables to avoid voltage drops.



**Attention:** To ensure safety and stability of the cluster always connect the Battery Modules using the feet.

1st

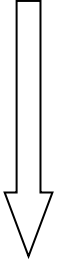

15th or Last

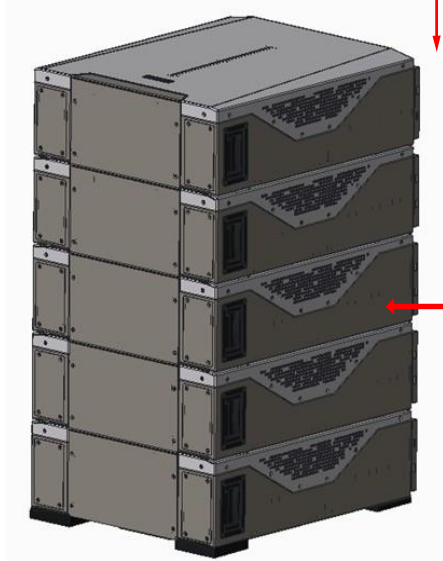

**Attention:**

Install the stackable flat front cover plate to protect the bus bar and cables

**BEFORE TURNING ON**

Battery Modules installed correctly, see image below.

1st

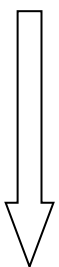

15th or Last

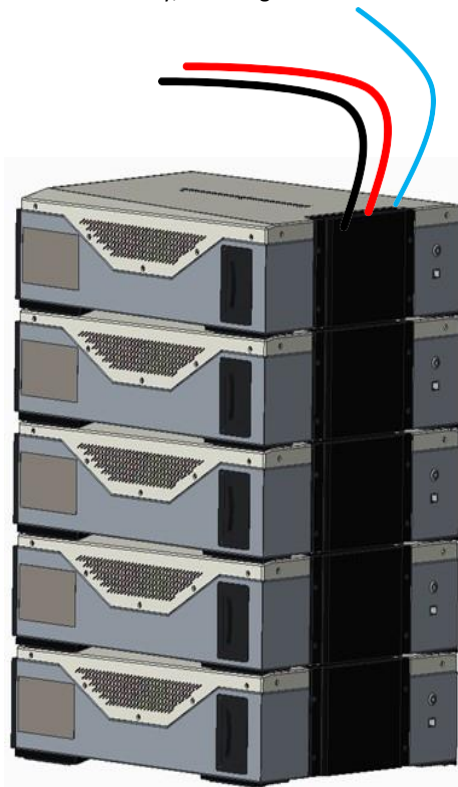

**Suggested  
Cable Output  
from the  
Upper Side**



**Attention:** Illustrations shown are for reference only. Please always refer to the physical Battery Module in front of you, and if the module has a different configuration to this manual, stop all activity immediately and contact your Deka Duration technical service representative.

## 2.5.5 LED Bar Indications

The LED bar is located on the front of the battery and is to be used as a visual indication.

### START UP



- 1- LED BAR Check. All the Blue LED will blink for 5 seconds
- 2- SOC GREEN LED will appear to indicate actual SOC

Warning Indicator ( Most of the time switched off)  
 SOC 81-100%  
 SOC 31-80%  
 SOC 6-30%  
 SOC < 5%

### OVER/UNDER TEMPERATURE



- 1- If the temperature rises above the BMS limits, the contactor opens
- 2- The LED BAR will start blinking in RED color

Warning Indicator  
 SOC 81-100%  
 SOC 31-80%  
 SOC 6-30%  
 SOC < 5%

### FIRMWARE UPGRADE



- 1- During the firmware upgrade the first blue LED is active for the entire upgrade process
- 2- When the upgrade process has been completed the LED BAR will turn to normal

### VOLTAGE MISMATCHING



- 1- If the voltage difference between modules is above 2V, all LED in orange color

Warning Indicator  
 SOC 81-100%  
 SOC 31-80%  
 SOC 6-30%  
 SOC < 5%

### MAJOR FAULT



- 1- Wrong Voltage reading or any abnormal reading
- 2- All the LED BARS will remain fixed RED color
- 3- The warning indicator will blink in RED color every 0.5 Sec
- 4- The SOC indicator is not displayed

### PROTECTION STATUS



- 1- If the current exceed the BMS limit
- 2- If the voltage exceeds the BMS limits (High or Low)
- 3- The full LED bar blinks in RED Color
- 4- The SOC Indicator is not displayed

After any major event that causes the BMS safety intervention, the BMS logic will allow four reconnection attempts, the first, after 4 minutes. If the same condition occurs again, the next three attempts will be every 4 hours for a maximum of 48 hours.

## 2.6 Stand Alone Battery Front Panel Control

### 2.6.1 Start Battery

Press the Run Button for 2-seconds. The GREEN RUN light should come on. The Battery Module has been activated normally.

### 2.6.2 Shut Down Battery

Press and hold the RUN Button for 5-seconds. The GREEN RUN light should go off. The Battery Module has been shut down normally.

### 2.6.3 Low Battery – Force Charge

**Prerequisite:** The **VOLTAGE** between the battery B + and B- terminals is **ZERO** and the **PANEL LIGHTS ARE OFF**.

Battery is in “Shutdown State.”

**Preparation condition before forced charging:** Connect the charger or the inverter with charging capability to the B+ and B- of the Battery Module to ensure charging capacity.

**Forced charging approach:** Short press the Battery Module Run Button, the battery RUN light will flash GREEN which means that the battery is entering the compulsory charging mode. If the battery receives adequate charging power (above 10 Amps/58V) within 90 seconds from pressing the button, the battery will continue to charge normally until a stable state is reached.

If the battery does not receive adequate charging power within 90 seconds after pressing the button, the battery will enter the shutdown mode once again.

During the forced charging period, the FRONT LED BAR low battery LED will be steady orange up to an SoC of 10% at which point the low battery LED will go out.

## 2.7 Parallel Battery Configuration

1. The voltage difference between any of the Battery Modules in the stack must not be greater than 2V, otherwise the BMS will not allow the batteries to be activated in a parallel connection.
2. SoC of each battery in the stack must be the same (Check the SOC of each individual battery module before connecting in parallel).
3. The power cabling between the Battery Modules must be in accordance with section 5.6 of this manual.
4. All DIP switches are configured in accordance with this manual.
5. The RS485 inter battery data connections must be properly connected as per section 5.6 of this manual. The data connection “Daisy Chain” must start from PORT-B of the master battery (do not install the RS485 on the PORT-A of the master battery as it will result in a fault).
6. Connect the CAN PORT of the master Battery Module with the CAN PORT of the inverter and make sure that the communication is working properly by checking the inverter display.
7. Before activating the system, the operator should check the cable connection carefully and make sure that all safety procedures are respected. Check the inverter settings and connection before turning on. In case of an inverter without communication, make sure to set the voltage and current value as per the charge/discharge parameters provided in this manual.

### 2.7.1 Activation of Parallel Batteries (From Master to last module for a maximum of 15)

Turn ON the Power Switch on all battery modules to be connected in parallel.

Press the Master RUN Button for 2-seconds. The GREEN RUN light should come on. The battery has been activated normally.

Each sub module will start up automatically.

### 2.7.2 Shutdown of Parallel Batteries

Press and hold the Master Run Button for 5-seconds. The GREEN RUN light should go off immediately. The GREEN RUN lights on the sub batteries will not be extinguished immediately.

The RED FAULT lights on the sub batteries' FRONT LED bars will start flashing after ten seconds and the GREEN RUN lights will remain on.

After one minute the RED Fault lights on the FRONT LED bars and the GREEN RUN Button lights on all sub batteries will go off.

Turn OFF the POWER SWITCH of each battery.

The parallel battery system has shutdown properly.



#### NOTICE:

When a Master battery is offline in a fault state, or has been manually shutdown, the entire cluster will go offline until the Master comes back online.

To restart the Cluster, it is mandatory to repeat the Cluster Start Up procedure. First make sure to shut down all batteries by setting the power switch to the off (0) position, then set all power switches to the ON (1) position and press the master RUN BUTTON to enable the startup process again.



#### NOTICE:

In a parallel battery system, we strongly advise not to switch off individual sub batteries when the system is running either in Charge or Discharge Mode. If there is a reason to switch off a sub battery, we recommend that the procedure described in 2.7.2 of this manual be followed.

Switching off an individual sub battery in a parallel system is possible in an adverse situation, but only as a last resort.

**2.7.3 LV Direct Parallel Connection WITHOUT Certified Inverter BMS Communication (Open-Loop)**

It is recommended to always use an inverter equipped with CAN communication as listed in this manual, however any inverter can be used with Deka Duration batteries by setting the voltage and current values according to the table below.

Note that for installations **WITHOUT** certified Inverter BMS Communications, the maximum number of battery modules per installation is limited to five in parallel (5). The DD21001 Low Voltage Hub must not be used without Certified Inverter BMS Communication.

LV/HV DD5300	Individual Module Setting	
Nominal DC Voltage	52	
Nominal Amp Hours	105 / Usable 100Ah	
Rated kWh Capacity	5.3 kWh	
Standard Charge Current	100 Adc	
Max Charge Current	110 Adc Peak	
Standard Discharging Current	100 Adc	
Max Discharging Current	200 Adc Peak 5 sec	
Min Voltage	50.5 Vdc	
Max Voltage	56.00 Vdc	
Warranty Terms Charge Current	50 Adc @ 77°F (25°C) 80% DoD	
Warranty Terms Discharge Current	50 Adc @ 77°F (25°C) 80% DoD	
Charging Current at Various Vdc at 77°F (25°C)	From 50.5 Vdc up to 54.2 Vdc Max 100A	From 54.5 Vdc up to 56.0 Vdc Max 10A
Operative Ambient Temperatures Without CAN Communication	From +50°F to +95°F (+10°C to +35°C)	
Operating Efficiency	98%	
Self-Discharge Rate	1% self-discharge per month @ 77°F (25°C)	
Memory Effect	None	
Performance Warranty Period	10 Years – see <i>Limited Warranty terms</i>	
Note	<p>Without CAN communication, it is not always possible to perform a correct calibration of the cells due to the lack of interaction with the inverter. It is therefore possible that the SoC 100% threshold is not reached.</p> <p>It is recommended to use the minimum and maximum settings indicated, and to monitor the charging process to ensure that the battery does not go into protection mode for Low or High Voltage, Temperature or Current.</p>	

L  
O  
W  
V  
O  
L  
T  
A  
G  
E

**2.7.4 LV Direct Parallel Connection WITH Certified Inverter BMS Communication (Closed-Loop)**

Note that for installations **WITH** certified Inverter BMS Communications the maximum number of battery modules per installation is limited to seven clusters of fifteen Battery Modules per cluster. The DD21001 Low Voltage Hub must be used when the installation has more than one cluster.

LV/HV DD5300	Individual Module Setting	
<b>Nominal DC Voltage</b>	52	
<b>Nominal Amp Hours</b>	105 / usable 100Ah	
<b>Rated kWh Capacity</b>	5.3 kWh	
<b>Standard Charge Current</b>	100 Adc	
<b>Max Charge Current</b>	110 Adc Peak	
<b>Standard Discharging Current</b>	100 Adc	
<b>Max Discharging Current</b>	200 Adc Peak 5 sec	
<b>Warranty Terms Charge Current</b>	50 Adc @ 77°F (25°C) 80% DoD	
<b>Warranty Terms Discharge Current</b>	50 Adc @ 77°F (25°C) 80% DoD	
<b>DC Voltage (extreme)</b> <i>BMS Safety Intervention Voltage Limits</i>	48.5 Vdc	58.4 Vdc
<b>Depth of Discharge</b>	Up to 100%	
<b>Operating Efficiency</b>	98%	
<b>Operating Temp</b>	-13°F to +149°F (-25°C to +65°C)	
<b>Charging Temp @ Max 0.1C</b>	+19.4°F to +32°F (-7°C to 0°C)	
<b>Charging Temp @ Max 0.25C</b>	+32°F to +113°F (0°C to +15°C)	
<b>Charging Temp @ Max 1C</b>	+59°F to +131°F (+15°C to +55°C)	
<b>Discharging Temp @ Max 0.5C</b>	+149°F to +131°F (+65°C to +55°C)	
<b>Discharging Temp @ Max 1C</b>	+131°F to +32°F (+55°C to 0°C)	
<b>Discharging Temp @ Range 0.1C to 0.5C</b>	+32°F to +19.4°F (0°C to -7°C)	
<b>Discharging Temp @ Max 0.1C</b>	+19.4°F to -13°F (-7°C to -25°C)	
<b>Self-Discharge Rate</b>	1% self-discharge per month @ 77°F (25°C)	
<b>Memory Effect</b>	None	
<b>Performance Warranty Period</b>	10 Years – see <i>Limited Warranty terms</i>	

L  
O  
W  
V  
O  
L  
T  
A  
G  
E

## 2.8 Power Connection of a Single Cluster

### -Double BUS BAR-



**ATTENTION:** Both ends of the cluster must be connected with two output cables 50 mm<sup>2</sup>. Cables length shall not exceed 250cm. The suggested output cable is composed of two sets of 50 mm<sup>2</sup> each.

**ATTENTION:** The terminal block pole can support a 19mm width Cable Lug.

2X 50 mm<sup>2</sup> = 2 cables 50 mm<sup>2</sup> connected to both poles

(Positive pole has two connection screws, Negative pole has two connection screws)

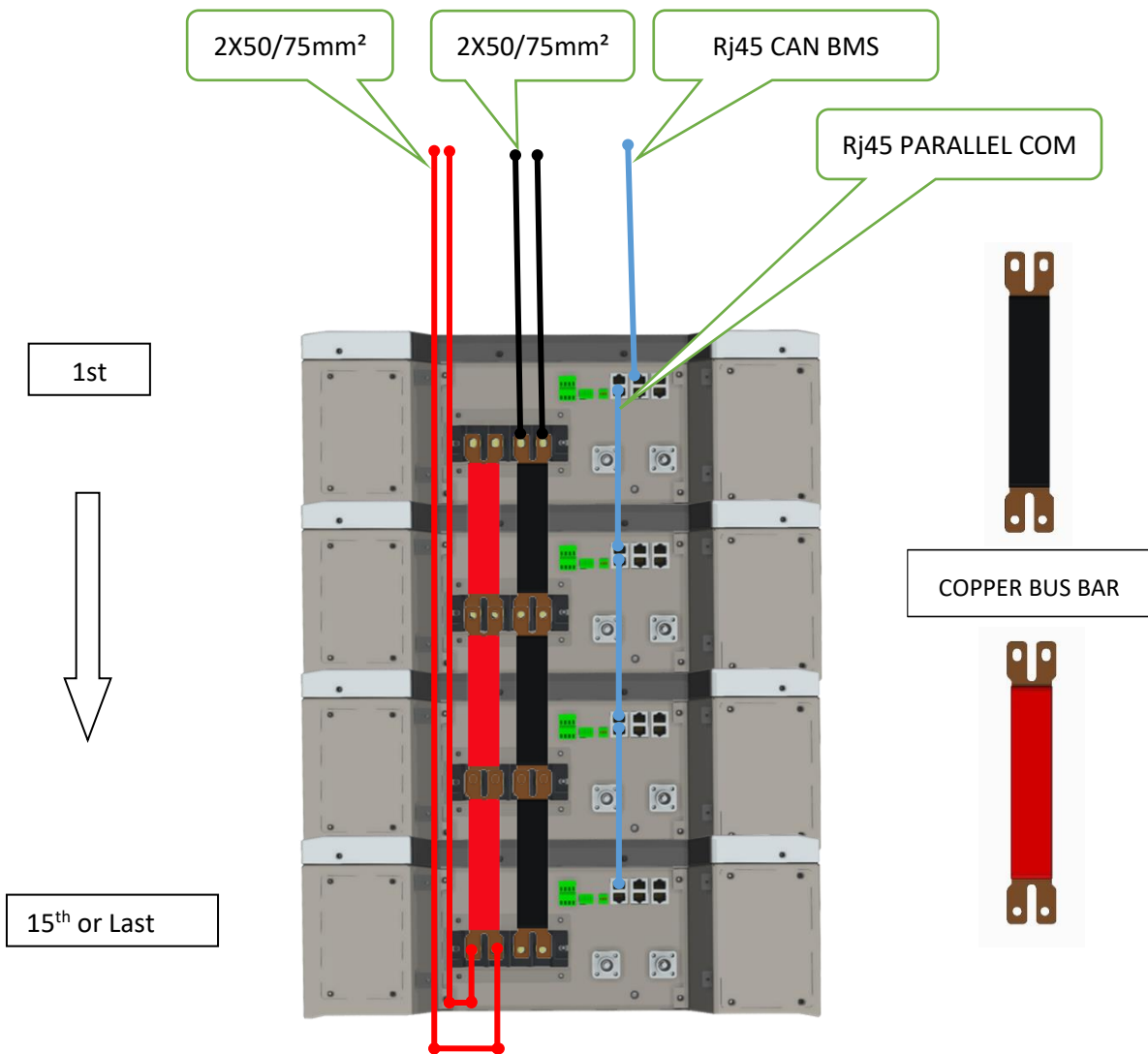

### INFORMATION



**14 Nm (10.33 ft lb)**

Terminal Block must be checked every 3 months.

Cable size verification for a cluster composed by 5 or more Battery Modules connected to the inverter with 2 sets of cables (50mm<sup>2</sup> each) for a total of 100 mm<sup>2</sup> each terminal (positive and negative).

Numbers of Modules	C-Rate	Current Allowance	Power W	Capacity kWh
1	1	100	5.200	5.20
2	0.98	196	10.192	20.38
3	0.96	288	14.976	44.93
4	0.94	376	19.552	78.21
5	0.92	460	23.920	119.60
6	0.9	540	28.080	168.48
7	0.88	616	32.032	224.22
8	0.86	688	35.776	286.21
9	0.84	756	39.312	353.81
10	0.82	820	42.640	426.40
11	0.8	880	45.760	503.36
12	0.78	936	48.672	584.06
13	0.76	988	51.376	667.89
14	0.74	1036	53.872	754.21
15	0.72	1080	56.160	842.40



## ATTENTION

The Battery Terminal Block can support max 50/75mm<sup>2</sup> on each connection point (two each pole). It is compulsory to set the maximum inverter current in accordance with the output cables capabilities.

A cable size calculator is available on [www.mkbattery.com](http://www.mkbattery.com)



## ATTENTION

Cable sizing must be calculated by a qualified technician/engineer, based on local regulations, and in accordance with overall system design.



## 2.9 CAN HUB for Multi Cluster Configuration

Required for installations of more than 1 cluster

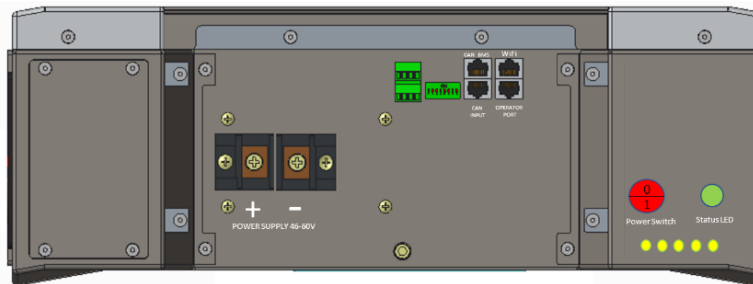

# DD21001 LOW VOLTAGE HUB



**SEE THE POWER/CURRENT CONFIGURATION  
SET THE INVERTER POWER AS PER THE CABLES' CAPABILITIES**

Each battery pack and each cluster must have the same Voltage and Firmware.

All stack configurations must use the DeKa Duration Bus Bar.

Each cluster must have the same number of Battery Modules.



This BMS BMU Master Hub is mandatory when more than one cluster is connected on a common bus bar.



The Master HUB works only with CAN communication approved inverters.

The DD21001 HUB can manage a maximum of 7 clusters composed of a maximum of 15 modules each.

A MULTI CLUSTER SYSTEM SHALL BE CONNECTED WITH BUS BAR BETWEEN MODULES.

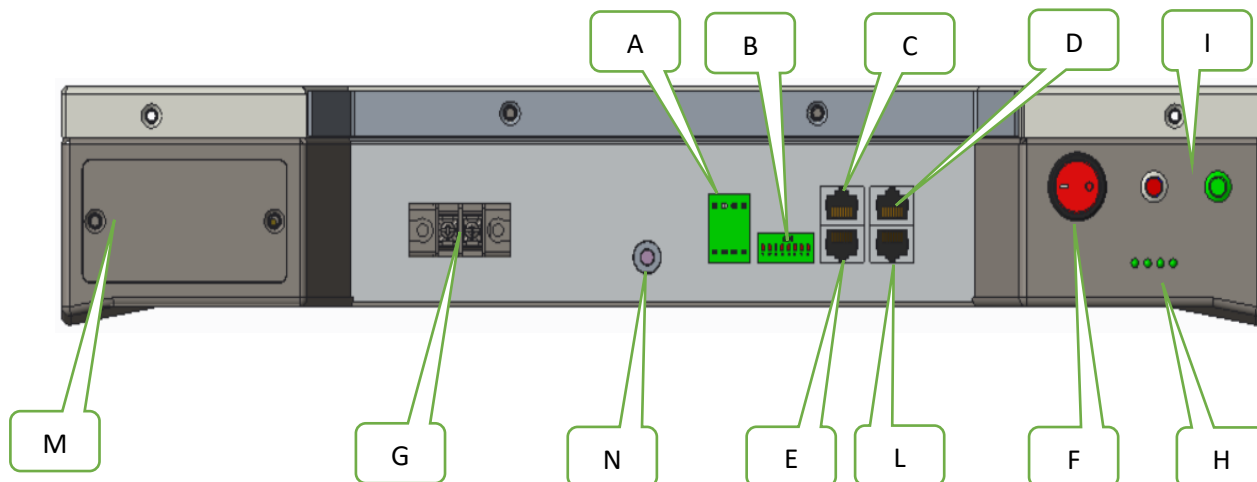

Interface Description and Connector		
A	I/O CONTACT 2X	Programmable closure/contact
B	DIP SWITCH	Baud Rate Selection
C	CAN BUS PORT	CAN / BMS Bus PORT for external solar – grid charger
D	WIFI PORT	Wi-Fi External PORT
E	CLUSTER CAN PORT	Master Cluster CAN from last master of the system
F	ON OFF SWITCH	Internal Power Supply Switch
G	INLET 48 Vdc	Connector for power input to connect to the bus bar (1A fuse inside)
H	SOC LED LIGHTS	SOC STATUS
I	STATUS LED	RED > POWER ON GREEN>COMM READY GREEN BLINK>NO COMM
L	OPERATOR PORT	OPERATOR PORT FOR RS232/USB converter
M	FUSE HOLDER	LV circuit Fuse
N	GND screw Connection	5mm Screw Terminal

### 2.9.1 Low Voltage CAN HUB Dimensions

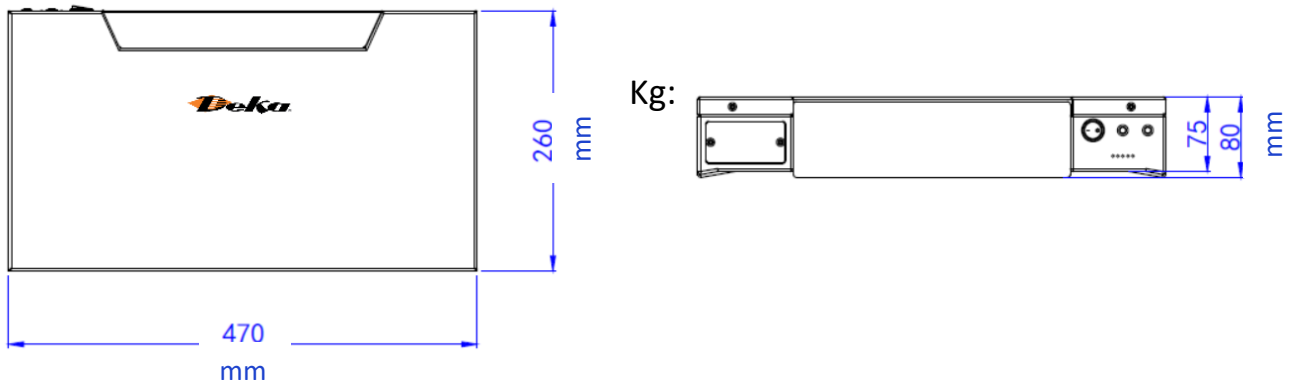

### 2.9.2 Control Logic and Protection Limit

The inverter, if applicable, must be set with the below restrictions in addition to the BMS control logic.

#### MAX CURRENT WITH BUS BAR

Modules	Clusters							
		1	2	3	4	5	6	7
1		100	196	288	376	460	540	616
2		196	376	540	688	820	936	1036
3		288	540	756	936	1080	1188	1260
4		376	688	936	1120	1240	1296	1400
5		460	820	1080	1240	1300	1500	1750
6		540	936	1188	1296	1500	1800	2100
7		616	1036	1260	1400	1750	2100	2450
8		688	1120	1296	1600	2000	2400	2800
9		756	1188	1350	1800	2250	2700	3150
10		820	1240	1500	2000	2500	3000	3500
11		880	1276	1650	2200	2750	3300	3850
12		936	1296	1800	2400	3000	3600	4200
13		988	1300	1950	2600	3250	3900	4550
14		1036	1400	2100	2800	3500	4200	4900
15		1080	1500	2250	3000	3750	4500	5250

- The charge current will be limited to zero Amps when the single module voltage has been reached (56.8V).
- The discharge current will be limited to zero Amps when the single module voltage has been discharged to 50.4V.
- The battery system will communicate with the inverter to limit the current.
- Each Battery Module will be protected by the same logic separately as per single module protection concept.
- If some modules, individually, reach any fault status, the single module will protect and disconnect from the system in less than 3 seconds.
- The current limit must be adjusted according to the real active batteries in system in order to restore the normal function.
- If the cluster is not balanced, the current limitation set from the HUB to the inverter will be sent in order to manage the rest of active modules and clusters. At the same time, the imbalanced modules or cluster will equalize in standby mode and will reconnect once in the normal range.
- If more than two batteries in one cluster are in protection mode, the entire cluster will protect by shutting down.
- If there are more than two clusters in protection mode, the full system will be protected.
- The battery sends information to the inverter to limit the charge/discharge current to zero Amps if the battery is detecting an over current.
- The protection built into the BMS will automatically disconnect the battery when it detects excess values. The BMS will attempt to reconnect up to three times to check if the excess values have returned to within the permitted range. After three attempts to reconnect, the BMS will not attempt any further reconnections. The Battery Module can be restarted using the module power switch and run button, however, if the external fault condition which caused the Battery Module to shut down is not rectified, the battery will continue to enter the shutdown mode.
- If the current of one cluster is larger than the current limit, the battery system will send a warning in accordance with the single module BMS logic.

### 2.9.3 CAN Hub General System Description

CAN Hub is Mandatory for Multiple Cluster Installation

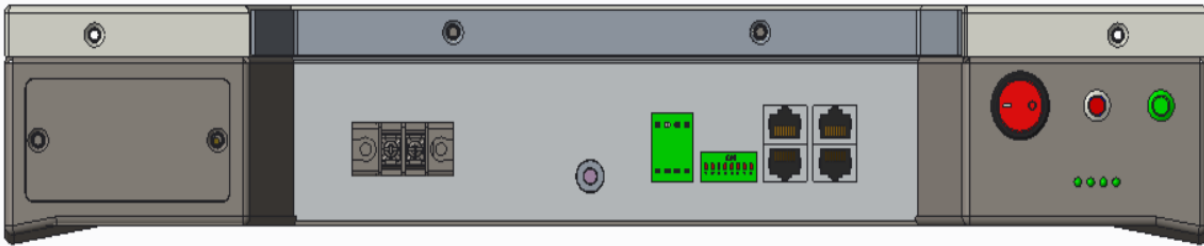

#### ATTENTION:

BEFORE PROCEEDING WITH THE DD22100 INSTALLATION IT IS MANDATORY TO READ THE INSTRUCTIONS BELOW

#### Special BUS Bar for Parallel Configuration

(MODULES INTERCONNECTION BUS BAR MODEL – ACCESSORY)



ATTENTION: BUS BARS ARE MANDATORY FOR STACK SYSTEM.



ATTENTION: DO NOT USE DIFFERENT BUS BAR TYPES OR CABLES.



ATTENTION: EACH BATTERY MODULE AND EACH CLUSTER MUST HAVE THE SAME SoC% and VOLTAGE.  
ALL THE BATTERY MODULES MUST HAVE THE SAME FIRMWARE.

## 2.9.4 Multi Cluster Configurations

Before using the MASTER HUB device, make sure to update the modules with the latest update Firmware available on [www.DD5300-BMS.com](http://www.DD5300-BMS.com).

**To use and set up the MASTER HUB, the installer must follow the instructions contained in this manual.**

1. It requires a minimum of three Battery Modules to a maximum of 15 Battery Modules per cluster.
2. It is possible to create up to 7 clusters with a maximum of 15 modules each for a total of 105 Battery Modules.
3. All the battery modules of each cluster must have all the DIP Switches set to 00000000 **with the only exception of the master module that needs to be addressed with the specific cluster ID.**
4. Each master battery of each cluster needs to be assigned with a unique and progressive ID as shown below.
5. The first cluster will have the ID 01 and needs to be connected from the CAN PORT 2A to the CAN PORT 1A of the consecutive Cluster that will have the ID02. Proceed with the Daisy Chain connection between Clusters up to the last.
6. From the master battery, of the last cluster needs to be connected the HUB from the CAN PORT 1A to the CAN INPUT PORT of the HUB.
7. The Connection of the power cables between HUBs must be executed in accordance with the previous instruction.
8. The HUB can be powered with 2 x 6mm<sup>2</sup> cables from the common bus bar to the INPUT terminal of the HUB.
9. The HUB is connected via CAN to the inverter from the HUB CAN BMS PORT.
10. When all the connections have been completed, it is possible to turn on the HUB with the POWER BUTTON.
11. Turn on all MODULES POWER SWITCHES.
12. Turn ON the RUN Button of the Master of each Cluster and wait for the auto wake-up of all the SUB modules.
13. According to the numbers of modules connected, the entire startup procedure could take up to 320 seconds to be completed.

### STARTUP

1. Stack all the modules in positions (Verify the load with a local civil engineer).
2. Connect each module to GND and to the Master GND node.
3. Assign each MASTER with a progressive ID following the DIP settings (max 7 Clusters).
4. Connect the MASTER ID01, starting from the CAN PORT 1A to the CAN PORT 2A of MASTER ID02 and proceed up to the last MASTER.
5. Connect the LAST MASTER from the CAN PORT 1A to the CAN INPUT PORT of the HUB.
6. Connect the CAN BMS PORT with the INVERT CAN PORT (follow the PIN OUT provided by the Inverter manufacturer for CAN L CAN H).
7. Assign each SUB module with Address 00000000.
8. Connect the RS485 from PORT B of the MASTER to the PORT A RS485 of the SUB1 and proceed in Daisy Chain up to the last module.
9. Turn ON the HUB Switch.
10. Turn ON the POWER SWITCH on all modules and press the MASTER RUN BUTTON for 2-seconds to start the wake-up process on all SUB modules.

### 2.9.5 Master ID Set Up and Connection Diagram

#### Communication Diagram

It is important to follow the diagrams below to make the connections in the correct sequence.

Each cluster must have its own unique address which will be assigned by the first battery of each cluster. All the batteries in the group except the first must have the DIP switches set to 00000000 (see picture):

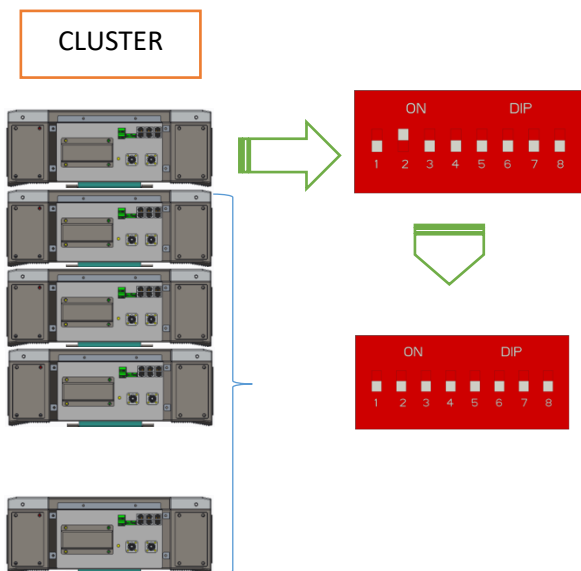

The First Battery of the cluster after being set with the ID (acting on the DIP switches) will auto assign all the sub Module addressees.  
 Example:  
 The Master Module of the cluster ID01 will be:  
 Master: **1.01**,  
 SUB 01: **1.02**  
 SUB 03: **1.03** and so on up to the last module.  
 The Master Module of the cluster ID02 will be:  
 Master: **2.01**,  
 SUB 01: **2.02**  
 SUB 03: **2.03** and so on up to the last module.

Only the first batteries of each cluster must be set following the sequence from ID 00 to ID 07 to allow the HUB to activate the related logic based on the number of modules present in each cluster (minimum 3, maximum 15), and based on the number of actual clusters connected to each other in a Daisy Chain (minimum 2 maximum 7).



**All the master batteries must be connected in Daisy Chain from the first module to the last module, connecting the CAN PORTS CAN1A and CAN2A to the last module from the CAN PORT CAN1A for connection to the HUB PORT -CAN INPUT-**

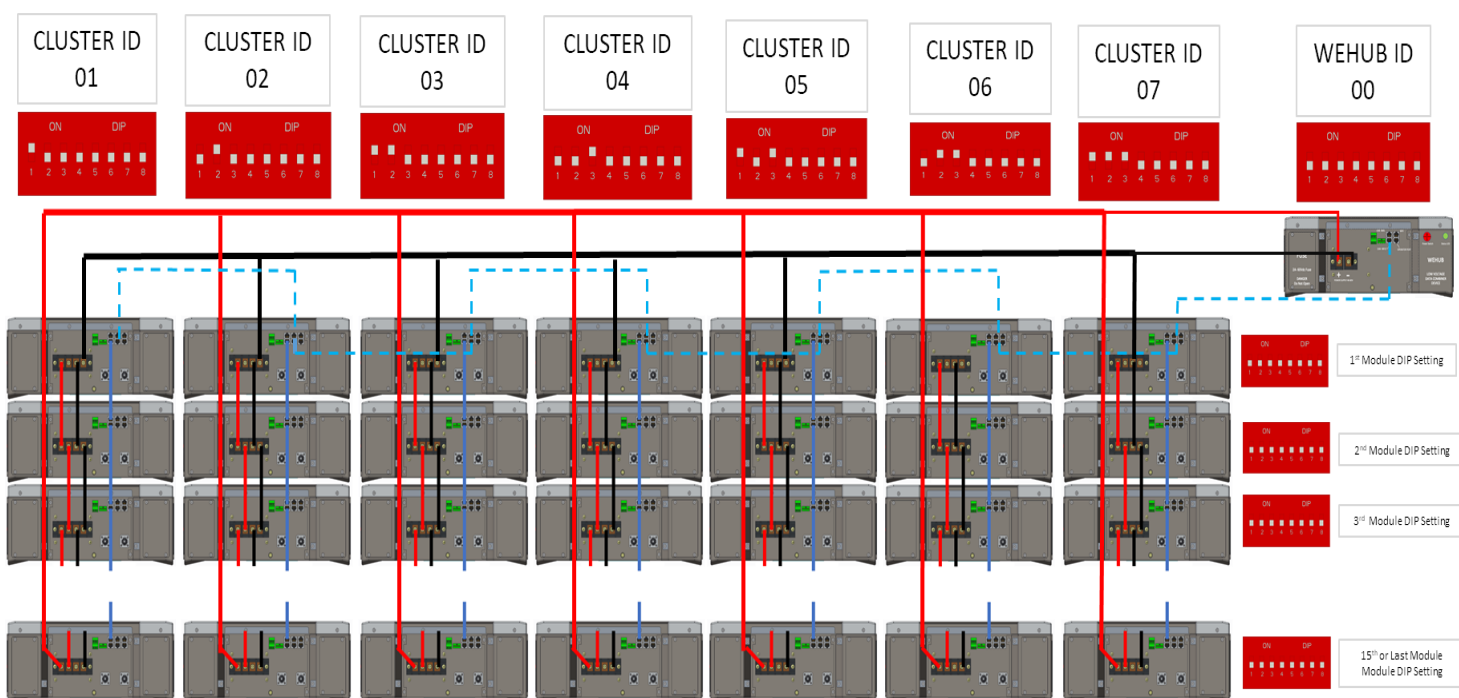

### 2.9.6 Power Connection Example

#### Communication Diagram + Power Connection

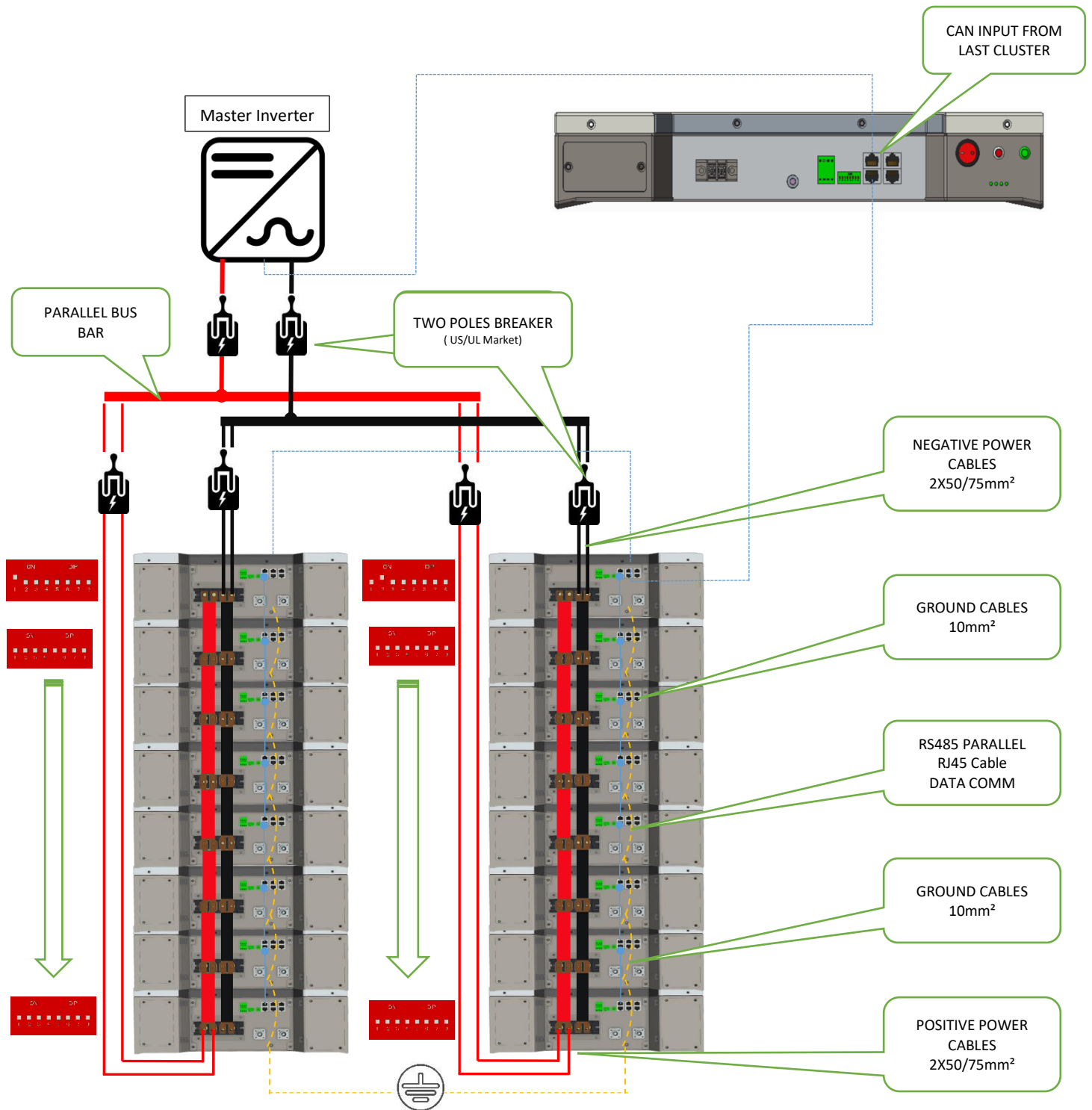

**ATTENTION:**

Each cluster must be equipped with an isolator to individually disconnect the battery tower from the parallel bus bar in accordance with UL regulations.



**ATTENTION:**

The circuit between the inverter and the parallel bus bar must be separated by a manual switch in accordance with UL regulations.

2.9.7 Conceptual Diagram of a Cluster composed of 5 clusters of 8 batteries each.

Note: It is possible to install up to 7 clusters composed of 15 batteries each for a total of 105 batteries.

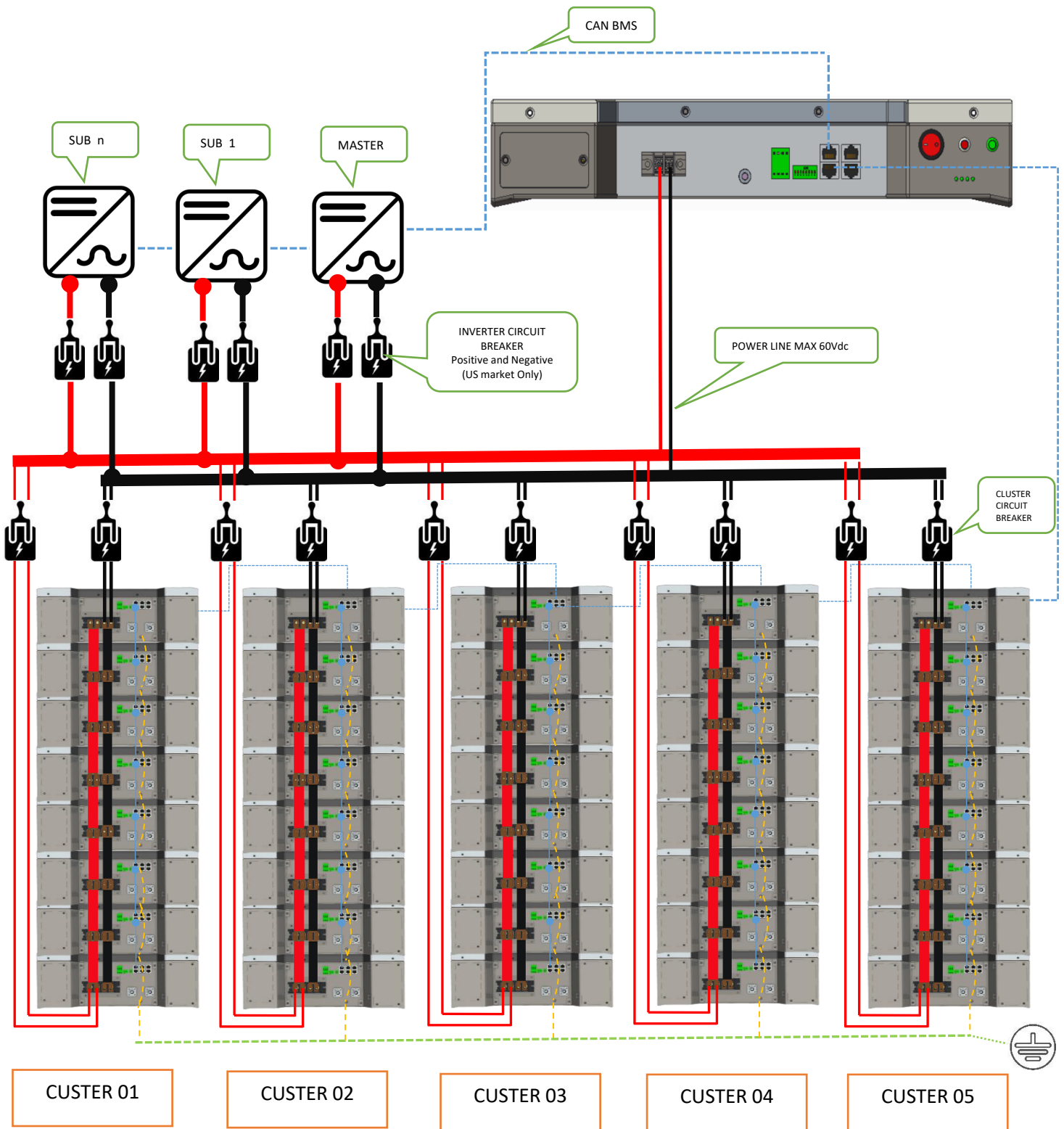



### 2.9.8 Conceptual Diagram between Master Modules of multiple clusters.

Note: It is possible to Install up to 7 clusters composed of 15 batteries each for a total of 105 batteries.

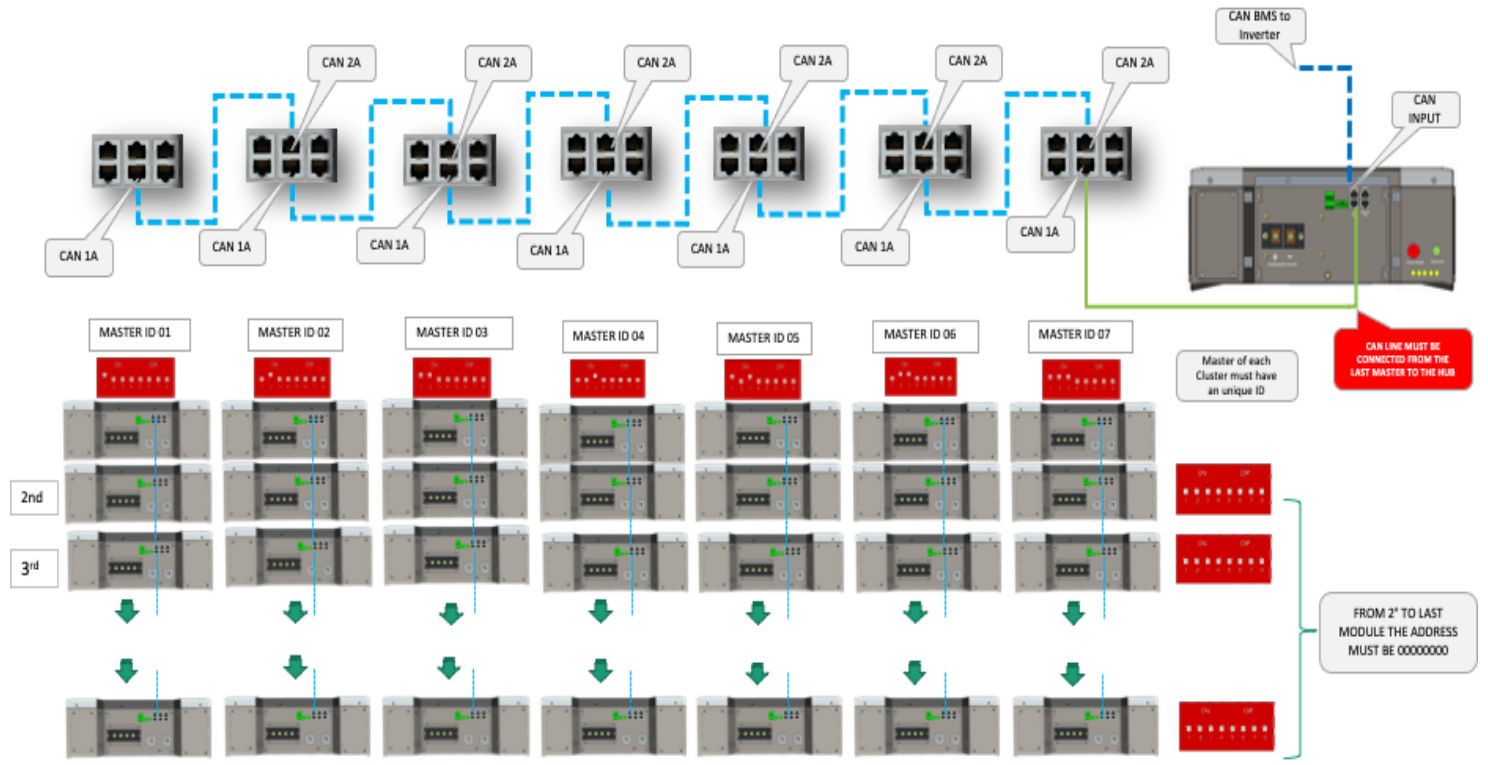

## 2.10 Cluster Configuration Accessories

### 2.10.1 Single Cluster Configuration Kit

DD21005 STANDARD LV BUS BAR KIT		
<p>1 x Custom BUS BAR Insulated RED module connection</p> <p>1 x Custom BUS BAR Insulated BLACK module connection</p> <p><b>ACCESSORY / NOT INCLUDED</b></p>		<p>Each kit includes 1 red + 1 black BUS BAR</p>

### 2.10.2 Multi Cluster Hub Device

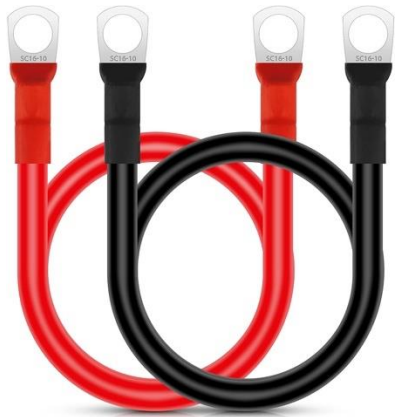

DD21001 MULTICLUSTER INTELLIGENT CAN BUS COMBINER HUB		
<p>1 x Parallel Controller</p>		<p>Packed in Carton</p>
<p>1 x Cable Power Supply</p>		

L  
O  
W  
V  
O  
L  
T  
A  
G  
E

## 2.11 Low Voltage Inverter Compatibility List

INVERTER BRAND		MODEL	Battery Protocol Selection	Module in Direct Parallel	Modules in Parallel with WeHub
	ZCS Azzurro	SP3000/HYD	WeCo CAN	8	40
	Deye	All	CAN00	15	105
	Phocos	CAN Version	VOLTRONIC CAN	15	105
	Schneider	XW	CONEXT CAN	15	105
	Solis	LV All	SOLIS CAN	15	105
	Growatt	SPH LV	GROATT CAN	15	105
	SMA	Sunny Island	SMA CAN	15	105
	Goodwe	S-All LV Hybrid	GOODWE CAN	15	105
	Studer Innotec	Xtender	STUDER CAN	15	105
	Sofar Solar	All	WeCO CAN	15	105
	Victron Energy	Via Colour Control	VICTRON CAN	15	105
	TBB	ALL	CAN00	15	105
	INVT-MEGA	LV All	INVT CAN	15	105
	Imeon Energy	All	IMEON CAN	15	105
	Voltronic Power	LV All	VOLTRONIC CAN	15	105
	Morningstar	Open Loop	OPEN LOOP	15	/
	Kehua Tech	Hybrid LV All	CAN 00	15	105
	Must Solar	PH / PV	OLP CAN	15	105
	Lux Power Tek	LV Hybrid All	WECO CAN	15	105
	Solax Power	SKU-LV All	SOLAX CAN	8	105
	Sungrow	SH3K6/SH4K6	WECO CAN	8	105
	Steca	Open Loop	OPEN LOOP	15	/
	OutBack (No BMS/ Alpha CAN)	Open Loop	OPEN LOOP	5	/
	TSUN	LV Hybrid All	WECO CAN	15	105
	INGETEAM	LV PLAY TL	WECO CAN	15	105
	MPP	LV ALL	OLP CAN	15	105

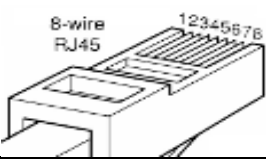
## 2.12 Low Voltage Inverter Battery to Inverter CAN Terminal Pin Out

	CAN TERMINAL	Inverter Terminal Type	Invertr Side (PIN Number)	Battery Side (PIN Number)																		
<b>SMA SUNNY ISLAND</b>	CAN L	RJ45	5	2																		
	CAN H		4	1																		
	GND		/	3																		
<b>ZCS HYD/SP</b>	CAN L	RJ9	2	2																		
	CAN H		1	1																		
	GND		3	3																		
<b>KEHUA SPH</b>	CAN L	RJ45	2	2																		
	CAN H		1	1																		
	GND			3																		
<b>GROWATT</b>	CAN L	RJ45	5	2																		
	CAN H		4	1																		
	GND		/	3																		
<b>DEYE</b>	CAN L	RJ45	5	2																		
	CAN H		4	1																		
	GND		2	g																		
<b>VOLTRONIC</b>	CAN L	RJ45	7	2																		
	CAN H		6	1																		
	GND		/	3																		
<b>PHOCOS</b>	CAN L	RJ45	7	2																		
	CAN H		6	1																		
	GND		/	3																		
<b>TBB</b>	CAN L	RJ45	5	2																		
	CAN H		4	1																		
	GND		2	3																		
<b>VICTRON</b>	CAN L	RJ45	8	2																		
	CAN H		7	1																		
	GND		2	3																		
<b>SOLIS</b>	CAN L	RJ45	5	2																		
	CAN H		4	1																		
	GND		2	3																		
<b>SCHNEIDER</b>	CAN L	GATEWAY Terminal	5	2																		
	CAN H		4	1																		
	GND			3																		
<b>INGETEAM PLAY M</b>	CAN L	Inner Terminal	CAN H	1																		
	CAN H		CAN L	2																		
	GND		/	3																		
<b>Battery RJ45 PIN DEFINITION</b>																						
	<table border="1" style="width: 100%; text-align: center;"> <tr> <td>Pin</td> <td>8</td> <td>7</td> <td>6</td> <td>5</td> <td>4</td> <td>3</td> <td>2</td> <td>1</td> </tr> <tr> <td>Definition</td> <td></td> <td></td> <td></td> <td></td> <td></td> <td>GND</td> <td>CAN L</td> <td>CAN H</td> </tr> </table>				Pin	8	7	6	5	4	3	2	1	Definition						GND	CAN L	CAN H
Pin	8	7	6	5	4	3	2	1														
Definition						GND	CAN L	CAN H														

L  
O  
W  
V  
O  
L  
T  
A  
G  
E

## SECTION 3 - HIGH VOLTAGE CONFIGURATION

### SERIAL CONNECTION AND SYSTEM CONFIGURATION

#### HIGH VOLTAGE STACKABLE CONFIGURATION



**ATTENTION:**

**THIS SECTION IS FOR HIGH VOLTAGE CONFIGURATION ONLY**

**IT IS COMPULSORY TO USE THE DD21002 HV BOX  
FOR THIS CONFIGURATION**

### 3.1 Product Introduction

The Deka Duration DD5300 Battery Modules can be used as an on-grid or off-grid energy storage system. It is not recommended to use this product for any purpose other than the intended purpose as described in this document.

Use of this product other than as described in this document will nullify the Product Warranty. The substitution of any components of this battery will nullify the Product Warranty.

The use of any components contained within or connected to this battery other than the products sold as part of this product or recommended by the manufacturer will nullify the Product Warranty.



**ATTENTION:** Do not exceed the number of 8 modules in each tower.



**ATTENTION:** The maximum number of Battery Modules that can be connected in series is 16.



**ATTENTION:** The DD21002 HV Box is a compulsory protection and communication device that must be installed for any High Voltage Configuration.



**ATTENTION:** Attempting to operate a system of Battery Modules with less than four modules in series or more than 16 modules in series will nullify the Product Warranty.

Battery Module Weight 126.3 lb (57.3 kg)



**ATTENTION:**

**EXAMPLE:**

A cluster of 12 Battery Modules weigh 1515.6 lb (687.6 kg). The support structure/floor must be properly inspected by a civil engineer before starting the installation of the modules.

#### 3.1.1 Identifying the Individual Battery Module

Dimensions	mm	593x470x163
Weight	lb (kg)	126.3 lb (57.3 kg)
Case Material	Type	Steel
Modules in series	Max No.	16
Stackable	Type	Yes
Digital Output	No.	2+2
Cell Distribution	P/S	16S



Cell type	mm	LiFePO4
BMS Charge Temp	°F (°C)	+19.4°F to +131°F* (-7°C to +55°C*)
BMS Discharge Temp	°F (°C)	+131°F to -4°F* (+55°C to -20°C*)
Suggested Storage Temp	°F (°C)	+77°F (+25°C) (shelf life 1 year)
Storage Temp/Time outside the suggested storage temperature	°F (°C)	-13°F to +131°F / 4 months (-25°C to +55°C / 4 months)
Self-Discharge @ STC 77°F (25°C)	%	1% per month
Self-Discharge outside the STC	%	< 3% per month

### 3.1.2 Product Identification and labels

The nameplate label describes the product parameters and is attached to the product. For details, please refer to the nameplate label of the product. For safety reasons, the installer must have a thorough understanding of the contents of this manual before installing the product.



HV BOX LABEL

		<h2>HV BOX</h2>
<b>East Penn Manufacturing Co.</b>		
Emergency Numbers		MK Battery: (714) 937-1033
Series	HV BOX - DD21002 (For DD5300 in HV Configuration)	
Model Type	DD5300	
Voltage Range	200-1500Vdc	
Number of Inputs	1+1	
Input Max Current	50Adc+50Adc	
Max Charging Current	100A	
Active Safety Protection	Automatic Contactor 200A	
Passive Safety Protection	Fuse 200A-1000Vdc	
Manual Breaker	125A/1000Vdc Manual Breaker	
Operative Normal Temperature	77°F (25°C)	
Storage Temperature	14°F to 131°F (-10°C to +55°C)	
IP Grade	IP21	
Standards	EMC (EN61000-6-3:2007/A1:2011/AC:2012) IEC 61000-3-2:2014    IEC 61000-3-3:2013 IEC 61000-3-1:2007    IEC 62619 UL1973	
Production Date		
<p>This product must be installed and maintained by qualified professional installers. Read warranty terms and conditions before use. Improper use and installation will void the warranty.</p> <p> Lire les modalités de la garantie avant l'utilisation. La garantie sera annulée si le produit n'est pas installé et utilisé de la bonne façon. Ce produit ne doit être installé et entretenu que par des installateurs qualifiés.</p> <p>Lea los Términos y condiciones de la garantía antes de instalar. Uso e instalación inadecuados anulará la garantía. Este producto debe ser instalado por personal altamente calificado igualmente prestar servicio.</p>		
		
RESPECT THE HV BOX POLARITY FROM BATTERY STRING		MADE IN CHINA
HV BOX – DD21002 is identical to model 5K3-XP HV BOX produced by WeCo. WeCo SGS Contract No. 801492.		

H I G H V O L T A G E

3.1.3 HV BOX Dimensions

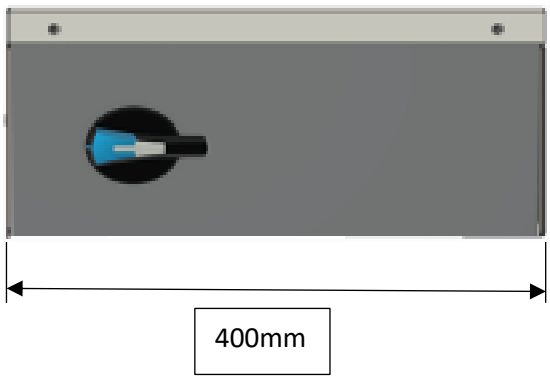
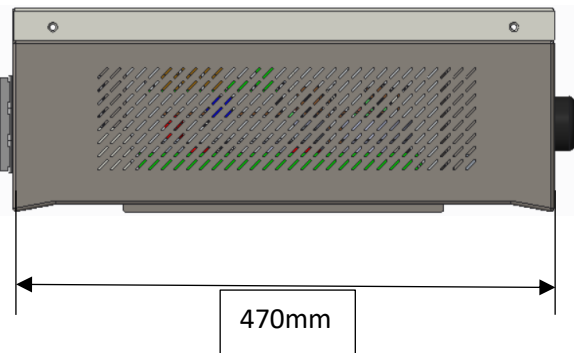

Dimensions	mm	400 x 470 x 170
Weight	lb (kg)	36.6 lb (16.6 kg)
Case Material	Type	Steel
Operative Voltage	Vdc	100-1000
IP	-	21









H  
I  
G  
H  
  
V  
O  
L  
T  
A  
G  
E



### 3.1.4 Battery Module Accessory List (Standard Kit)

The Battery Module is packed in a carton together with standard accessories. When unpacking, be sure to check that the Battery Module and accessories are free from damage and that the correct quantities of each component are included within the carton.

The following list of components can be used as a checklist when unpacking the individual Battery Module and accessories:









Cable Diameter	Cable Color	Cable Length	LV Kit Description	Quantity	Picture
25mm	BLACK	250 cm	Both sides ring terminal diam 8mm for LV connection <b>Not Required for HV Installation</b>	2	
25mm	RED	250 cm	Both sides ring terminal diam 8mm for LV connection <b>Not Required for HV Installation</b>	2	
CAT 5	BLUE	120 cm	RJ 45 RJ 9 BMS to Inverter CAN <b>Not Required for HV Installation</b>	1	
CAT 5	BLUE	120 cm	RJ 45 RJ 45 LV PARALLEL CABLE <b>Not Required for HV Installation</b>	1	
Wall Bracket			Wall Plate for Battery Support + 4 M10 Wall Plugs + Screws		
Removable Brackets			Set of 2 back brackets with M6 screws (Allen Key) for wall installation	Set	
Lifting Handles			2 X Lifting Handles	1 Set	
Insulated Rubber Support Pads w/ Adhesive			4 X Each Module	4	
Cable Diameter	Cable Color	Cable Length	HV Kit Description	Quantity	Picture
25mm	RED	25 cm	String double side fast connector, one side black – one side red <b>For HV Serial Connection Only</b>	1	
CAT 5	BLUE	20 cm	Link + CAN HV communication cable 2 sides RJ45 <b>For HV Battery Data Communication Link</b>	2	

H  
I  
G  
H  
V  
O  
L  
T  
A  
G  
E

3.1.5 HV BOX KIT (Included in the carton box)

Cable diameter	Cable color	Cable Length	DESCRIPTION	QTY.	
25mm	RED	20 cm	DD5300 1st Module to HV BOX double side fast connector, one side red – one side red	1	
25mm	BLACK	250 cm	DD5300 last Module to HV BOX double side fast connector, one side black – one side black	1	
25mm	RED	250 cm	Serial connection between towers double side fast connector, one side black – one side black	1	
DI/DO Terminals			DI/DO green Terminals	2	
10mm	RED	250 cm	From inverter to HV BOX power charging cable, one side fast connector black – one side STAUBLI blue	2	
CAT 5	BLUE	220 cm	CAT 5 LINK/CAN for towers connections 220 cm RJ 45	2	
10mm	BLACK	250 cm	From inverter to HV BOX power charging cable, one side fast connector black – one side STAUBLI blue	2	
10mm	GREEN or GREY	250 cm	RJ 45 CAN BMS from HV BOX to inverter	1	
Rubber Pads 10x50x20			Rubber insulated supports for tower 01 and tower 02	4+4	
Rubber Pads for Stack Installation			Rubber tape pads 70x70 5mm thickness, for single module insulation	4	

3.1.6 Necessary Installation Tools

 <p>Multimeter + Current clamp</p>	 <p>Insulated Screwdriver Set</p>	 <p>Insulated Allen Key Set</p>	 <p>Drill + Hammer</p>
 <p>Electrician Scissors</p>	 <p>Insulated Torque Wrench Set</p>	 <p>Lifting Strap + Mechanical Lifter</p>	 <p>RS 232/USB + Screw Terminal (insulated)</p>

3.1.7 Personal Protective Equipment + 1000 Vdc Insulated Tool Kit



H  
I  
G  
H  
  
V  
O  
L  
T  
A  
G  
E

## 3.2 High Voltage Battery Module Wiring and Set Up

### 3.2.1 Battery Connections

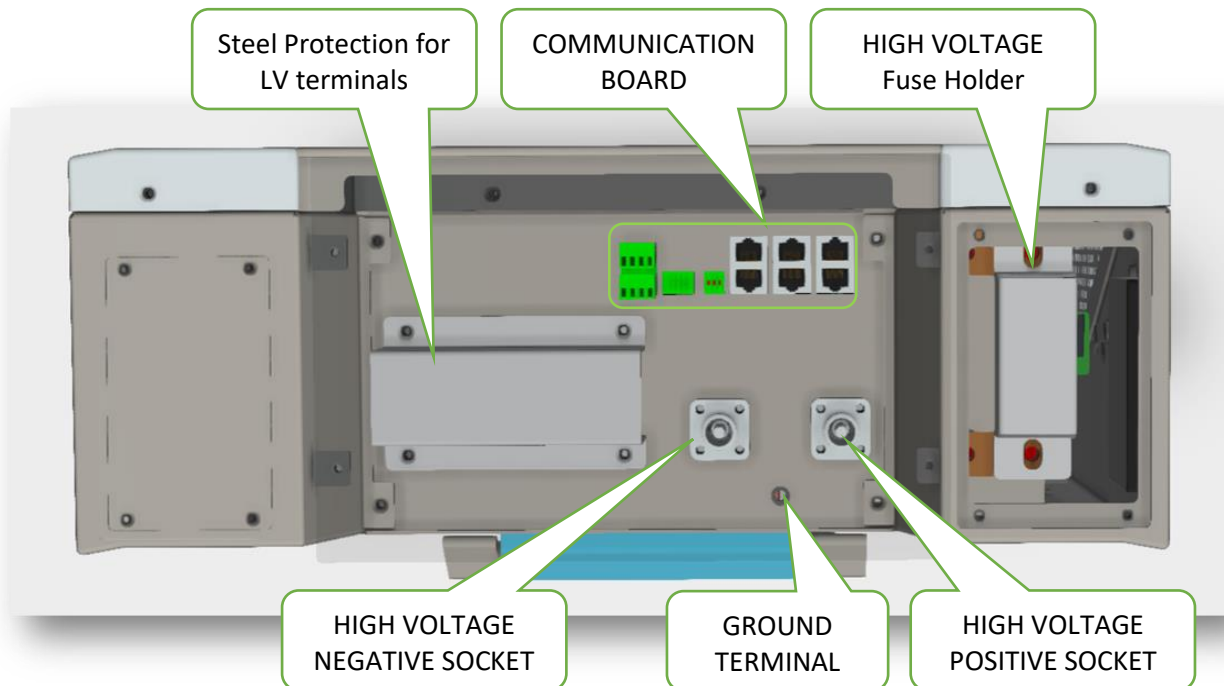

### Module Communication Board

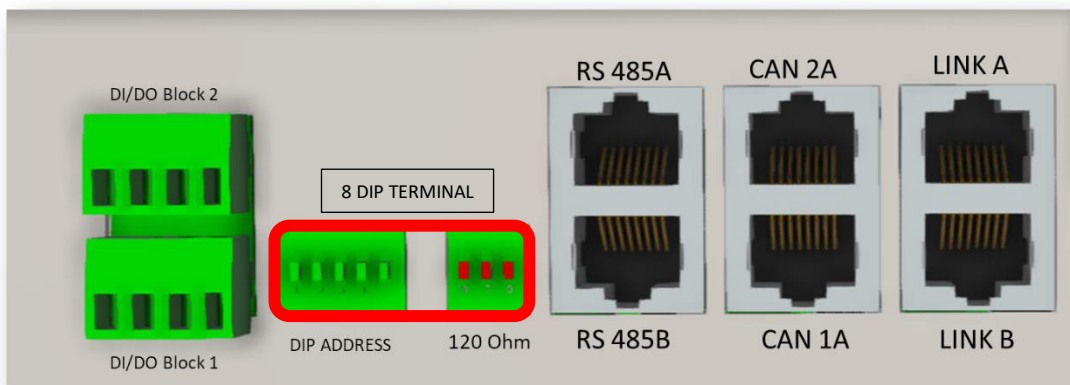

**CAUTION:** The LV fuse is contained in the left portion of the module as shown above. The access to the fuse is restricted to authorized Deka Duration service personnel, and the protection lid cannot be opened by anyone else. The same applies to the HV fuse.

**Battery Terminal Definition table**

The terminal layout is shown in the following figure:

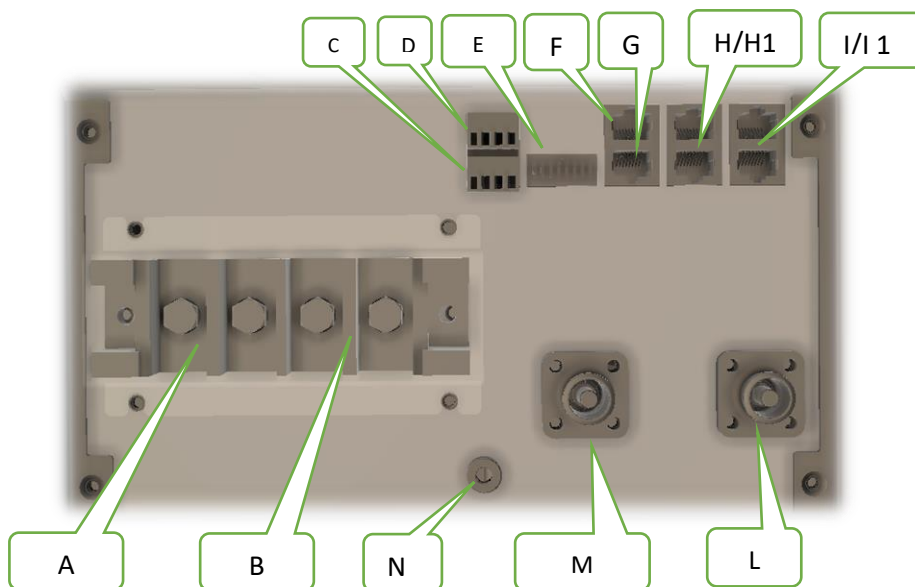

Module Definition Table		
Interface	Name	Function
A	LV POLE +	LOW VOLTAGE POSITIVE (+) Screw Terminal <b>(NO USE IN HV CONFIGURATION)</b>
B	LV POLE -	LOW VOLTAGE NEGATIVE (-) Screw Terminal <b>(NO USE IN HV CONFIGURATION)</b>
C	D/I	DIGITAL INPUT
D	D/O	DIGITAL OUTPUT
E	DIP SWITHC	8 PINS DIP SWITCH
F	RS485A	RS 485 PORT A FOR PARALLEL CONNECTION
G	RS485	RS 485 PORT B FOR PARALLEL CONNECTION
H/H1	CAN LINE	CAN A CAN B (CAN A is also used as communication between inverter and hub)
I/I1	LINK	LOW VOLTAGE COMMUNICATION BETWEEN MODULES
L	HV POLE -	HIGH VOLTAGE NEGATIVE (-) Fast Connector Terminal for serial connection
M	HV POLE +	HIGH VOLTAGE POSITIVE (+) Fast Connector Terminal for serial connection
N	GND	Ground Terminal

H  
I  
G  
H  
  
V  
O  
L  
T  
A  
G  
E

### 3.3 HV BOX Overview

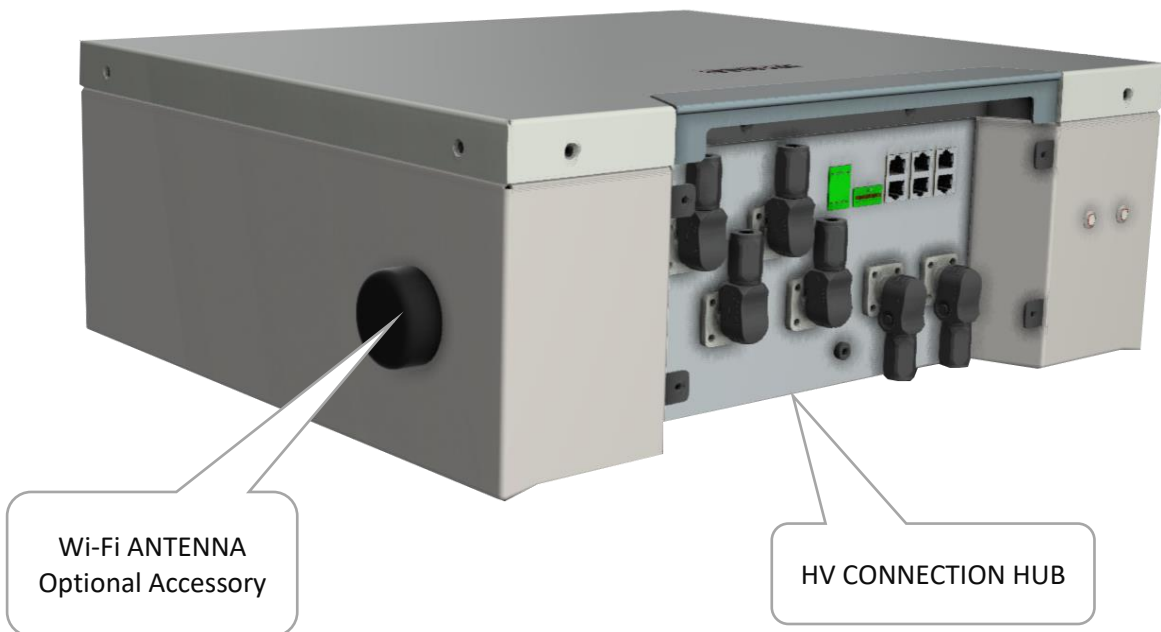
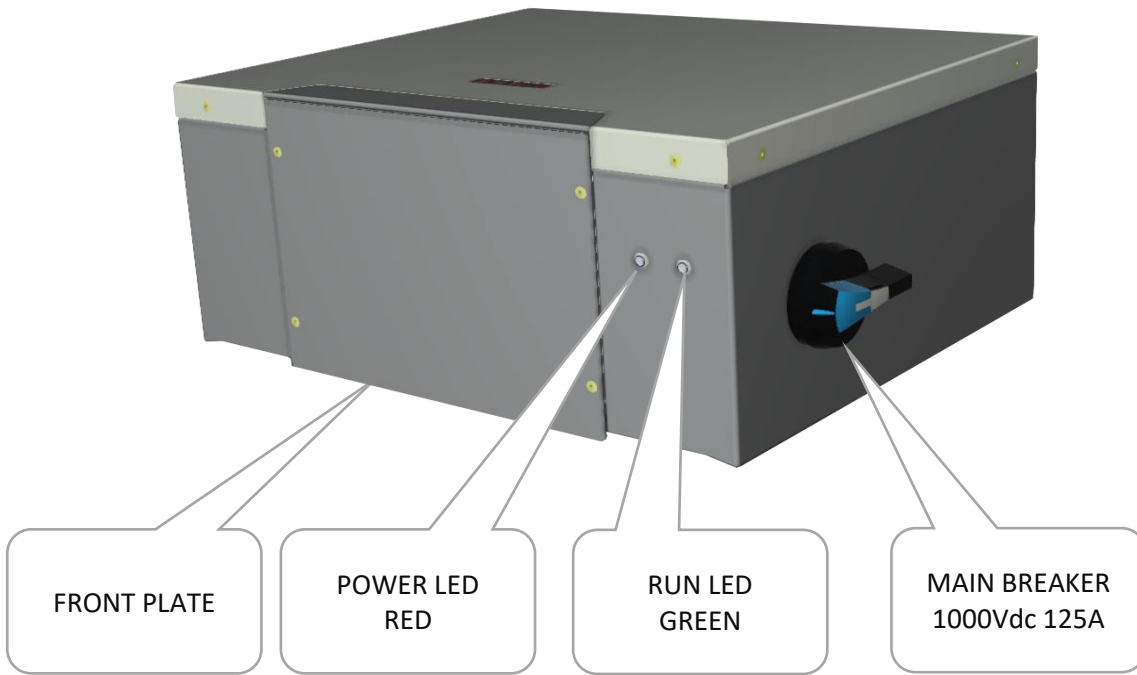

HV BOX Terminals Definition Table

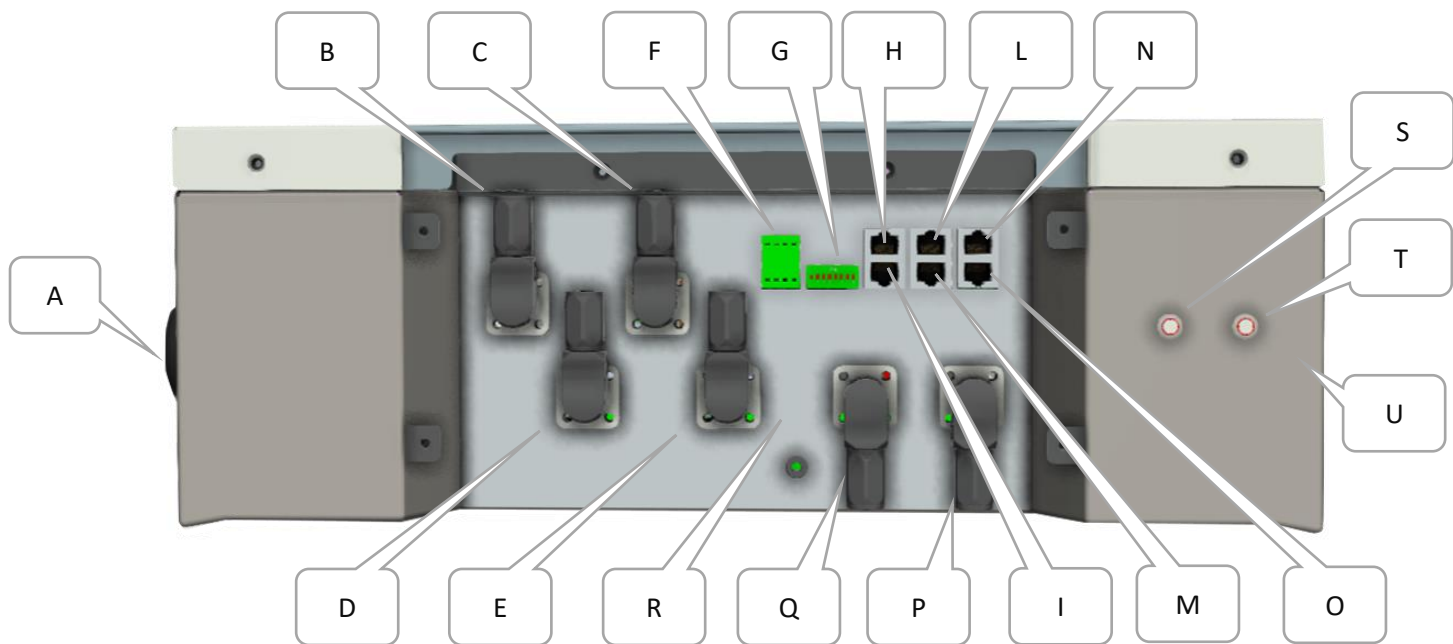

Interface	Name	Function
A	WIFI ANTENNA	WiFi ANTENNA * (Optional)
B	INPUT CHANNEL +	POSITIVE INPUT FROM THE INVERTER CHANNEL 01 POSITIVE PLUG (+) MAX 50A
C	INPUT CHANNEL -	NEGATIVE INPUT FROM THE INVERTER CHANNEL 01 NEGATIVE PLUG (-) MAX 50A
D	INPUT CHANNEL +	POSITIVE INPUT FROM THE INVERTER CHANNEL 02 POSITIVE PLUG (+) MAX 50A
E	INPUT CHANNEL -	NEGATIVE INPUT FROM THE INVERTER CHANNEL 02 NEGATIVE PLUG (-) MAX 50A
F	D/I – D/O	Digital Input / Digital Output (Both Terminals are programmable via PC Software)
G	DIP TERMINAL	DIP SWITCH TERMINAL (Address)
H	CAN PORT 2-A	RJ45 CAN 2-A PORT (Inverter interface)
I	CAN PORT 2-B	RJ45 CAN 1-A PORT (Line for connection with SUB HV BOX)
L	CAN PORT 1-A	RJ45 CAN 2-B PORT (Connection with the First battery Module)
M	CAN PORT 1-B	RJ45 CAN 1-A PORT (Line for connection with SUB HV BOX)
N	LINK -A	NOT USED
O	LINK -B	RJ45 LINK (Line for connection with first battery module)
P	BATTERY INPUT +	POSITIVE CONNECTION FROM THE POSITIVE TERMINAL OF THE BATTERY
Q	BATTERY INPUT -	NEGATIVE CONNECTION FROM THE NEGATIVE TERMINAL OF THE BATTERY
R	GROUND	GROUND TERMINAL
S	POWER LED	POWER LED (RED COLOR = POWER OK)
T	STATUS LED	COMM and STATUS LED STEADY GREEN= RUN, BLINK= IDLE COMM LOSS or MODULE FAIL)
U	MAIN BRAKER	1000Vdc 125A MANUAL MAIN BREAKER (Located on the side)

Attention: Interface E: RJ45 PORT corresponding to the CAN bus pin definition

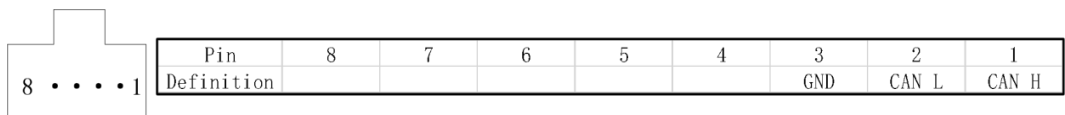

### 3.4 High Voltage Module Configuration



ATTENTION: The High Voltage mode mandates that the Battery Modules must be connected in series.



ATTENTION: The following table provides the possible module configurations. NO OTHER configurations are suitable.



ATTENTION: Before connecting an HV inverter with the HV BOX terminal, always check the Inverter Input range.

DD21002 HV Box				
Tower -1	n°	Min Vdc	Max Vdc	Capacity kWh
Modules in Series	4	200	233.6	20.8
	5	250	292	26
	6	300	350.4	31.2
	7	350	408.8	36.4
	8	400	467.2	41.6
Tower -2	n°	Min Vdc	Max Vdc	Capacity kWh
Modules in Series	9	450	525.6	46.8
	10	500	584	52
	11	550	642.4	57.2
	12	600	700.8	62.4
	13	650	759.2	67.6
	14	700	817.6	72.8
	15	750	876	78
	16	800	934	83.2



**ATTENTION**

For the calculation of the energy of a cluster (in both LV and HV systems) the nominal capacity of a battery is generally counted in 5.3kWh as a result of the multiple connection inefficiency, estimated at a loss of 2%.



### 3.5 High Voltage DIP Switch Settings



#### ATTENTION:



ALWAYS CONFIGURE THE DIP SWITCH SETTINGS BEFORE CONNECTING ANY POWER CABLES TO THE BATTERY HV TERMINALS.



WHEN CHANGES HAVE BEEN MADE TO DIP SWITCH SETTINGS, THE BATTERIES MUST ALWAYS BE RESTARTED FOR THE CHANGES TO TAKE EFFECT.



POWER CABLE CONNECTIONS MUST BE MADE IN STRICT ACCORDANCE WITH THE INSTRUCTIONS IN THIS MANUAL. INCORRECT POWER CONNECTIONS CAN DAMAGE THE BATTERY AND CAUSE INJURIES.



**ATTENTION:** All drawings are for reference only. Always refer to the physical product as the standard. If the manual does not match the physical product, stop all actions, remove any connections and store the batteries in a safe place. Call your Deka Duration technical representative for assistance.

### 3.5.1 Serial Tower Connection #1 Set-Up of the HV Box CAN Communication Loop

Four batteries connected in series is the minimum allowed configuration for High Voltage operation:



**CAUTION:** After setting the DIP switches, the batteries must be restarted for the DIP switch changes to take effect.

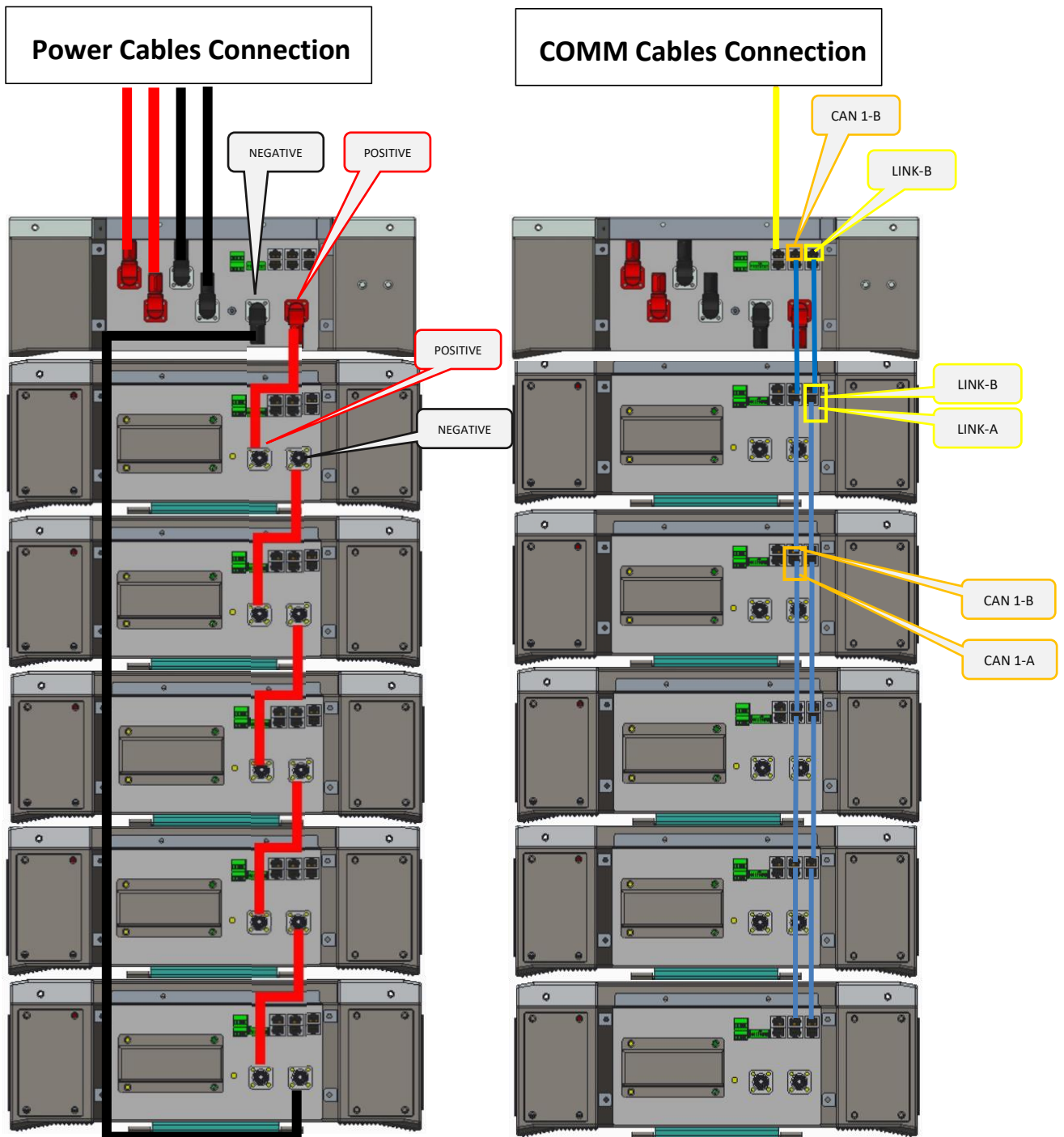

### 3.6 Serial Battery Wiring Connections



#### ATTENTION:



**POWER CABLE CONNECTIONS MUST BE MADE IN STRICT ACCORDANCE WITH THE INSTRUCTIONS IN THIS MANUAL. INCORRECT POWER CONNECTIONS CAN DAMAGE THE BATTERY AND CAUSE INJURIES OR SERIOUS DANGER AND DAMAGES.**



**Attention:** Screws, Cables and Bus Bar POWER CONNECTIONS must be installed with due diligence, and the tightening of the connection terminal must be to 14Nm (10.33 ft lb). Each terminal should be inspected, and its torque checked every three months.



**Attention:** All drawings are for reference only, always refer to the physical product as the standard. If the manual does not match the physical product, stop all actions, remove any connections, store the batteries in a safe place and call your Deka Duration technical representative for assistance.



**Attention:** For power cable connection for high current connection diagram, please refer to the specific section. Charging current limitation is mandatory as per this instruction manual.



**Attention:** Do not use anything other than Deka Duration supplied power and data cables.

### 3.6.1 High Voltage Power Connections

DD21002 HV Box can support maximum of 16 modules (934Vdc string Voltage).

Proceed with the physical installation of the desired quantity and configuration of the Battery Modules, following the installation sequences and guidelines as described in Section 1 of this manual.

Connect the power cables as indicated, making sure that the batteries are OFF (check the button LED on the bottom).

Do not connect the HV Box to the inverter input cables and do not turn on the HV Box breaker before serial connection completion.



Do Not Connect the Inverter until the HV Box is completely set up



Do Not Connect the HV Box with the inverter at this stage

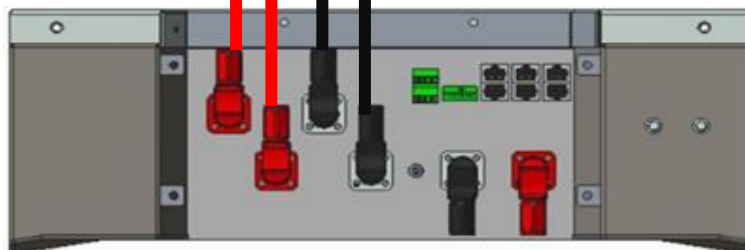
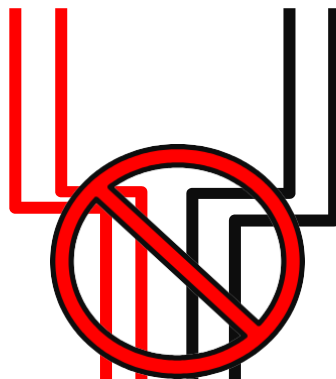

Keep the Breaker OFF

### 3.6.2 DATA Connections (Example of 12-Modules)

**Step 1:** Set up the DIP Switches as per the picture below.

**Step 2:** Connect the CAN and Link PORTS, starting from the HV Box PORT CAN A and LINK, then chain connection as shown below.



The HV Box must be set up before turning it on. The DIP addresses must follow the picture below to enable the CAN communication. The last module of the series must be terminated by addressing the module as shown in the picture to end the CAN line.



Single HV Box



Battery Module



End of series

**Step 3:** Link all modules and the HV Box with 6 mm earthing cables (In/Out) by using the GND connections point.





Make sure that the ground connection is not shared with other potential distributing devices, and that the ground rod is not used for Neutral Line dispersion or Harmonics mitigation circuit.

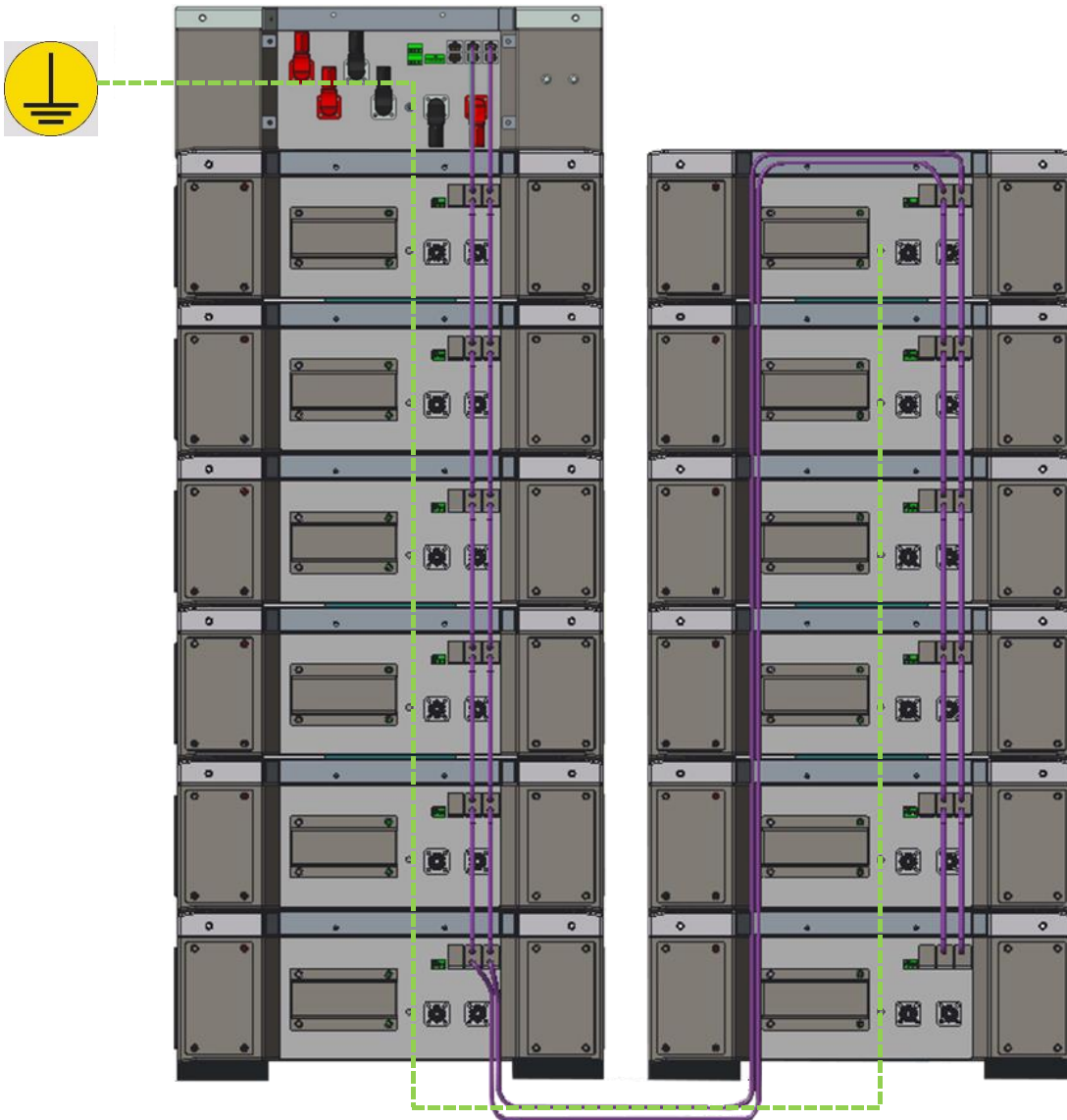

### 3.6.3 HV Box and Battery Module Power Connection

**Step 1:** Keep the power box main breaker OFF (located on the side).

**Step 2:** Connect the positive terminal of the HV Box to the Positive terminal of the 1<sup>st</sup> Battery Module.

**Step 3:** Proceed with the serial connection between all the modules.

**Step 4:** Connect the negative output from the last module to the negative input of the HV Box.

**Step 5:** Connect the Inverter Input Channels to the inverter (follow the inverter manual).

**Step 6:** Turn on the HV Box breaker and wait for the start-up automatic procedure.

**Step 7:** The HV Box will end the startup procedure within 60 seconds by closing the input circuit. The RED and the GREEN light will turn on, confirming the working status of the HV Box.

**Step 8:** Each module will turn on automatically and the side button will blink for 3 seconds, then a fixed GREEN light will confirm the run status of each module.

**If one or more modules do not turn on automatically, it is necessary to check all the COM connections and restart the START UP procedure.**

**ATTENTION:** In the event of missed communication between the inverter and HV BOX for more than 60 seconds, the HV BOX will enable the safety procedure by opening the POWER CONTACTOR.

During the commissioning phase the installer must ensure that the communication between the HVBOX and the Inverter is correctly connected.

Do not leave the system powered in absence of communication between the HV BOX and the Inverter, a prolonged standby of the cluster could cause an imbalance caused by the natural self discharge.

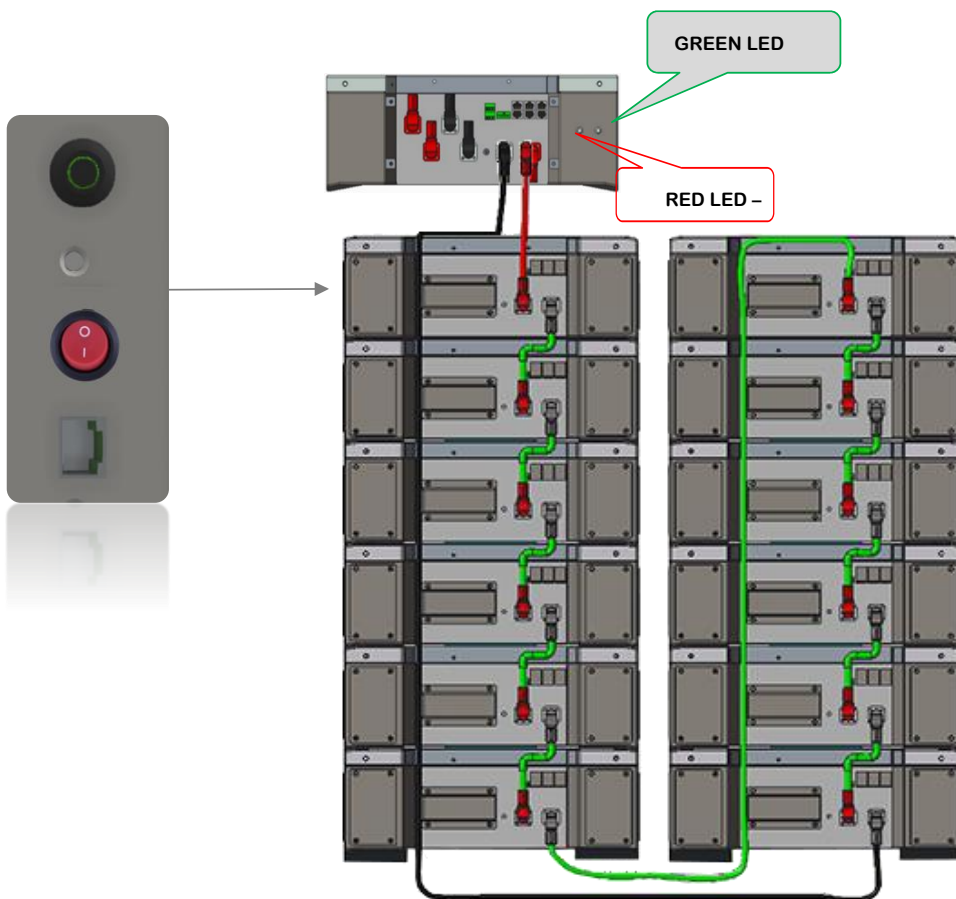

**Information:** Arrange the cables according to the specific installation requirements, always paying attention to minimize the length of the cables to avoid voltage drops.

Note: if the system is composed of more than 6 modules, it is required to arrange them as per the image.

**Alternate arrangements are strictly prohibited.**



### 3.6.4 Single HV Box Connection to an Inverter

**Step 1:** Turn the HV Box off by switching off the MAIN BREAKER located on the right side.

**Step 2:** Turn the Solar Inverter OFF.

**Step 3:** Connect the RJ45 cable into the CAN PORT 2A and perform the connection as per the Inverter Manual by following the PIN layout provided below. Make sure the CAN L and CAN H are matching the Inverter Terminal.

**Step 4:** Connect the Power Inputs from the inverter into the H+ and H- terminals.

**Step 5:** Turn on the HV Box main breaker.

**Step 6:** Wait for the startup completion of the power box (GREEN LED) and then turn on the Inverter.

#### Connection and Settings for HV Box

SINGLE CLUSTER WITH CAN ADDRESS 00

CAN TO INVERTER

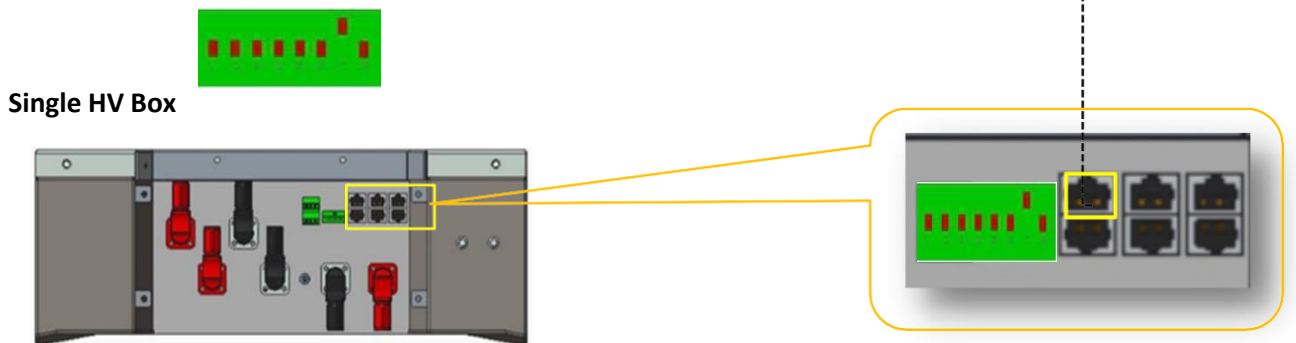



### 3.6.5 Multi HV Box Connection

Multi Clusters Communication Cable Connection

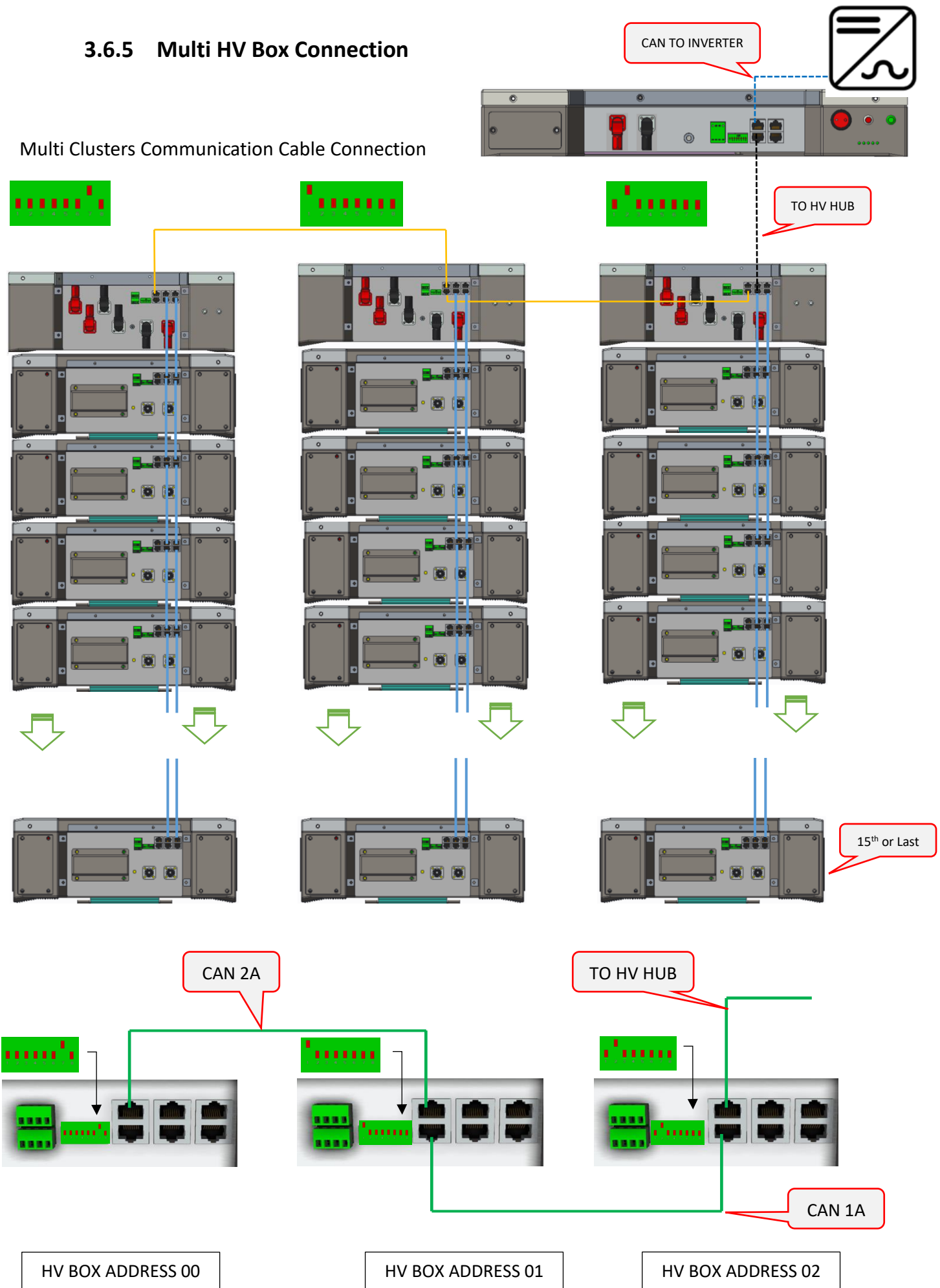

### 3.6.6 Multi HV Box Connection

**General Instructions**

In a Multi Cluster Connection with only one inverter CAN Connection Line, it is necessary to use the HV HUB and connect in Daisy Chain all the HV BOXES of each Cluster.

When more clusters are connected together, it is necessary to use an HV HUB combiner to collect all the battery information and transfer it to the CAN inverter.

The CAN communication between the various HV BOXES has to be in Daisy Chain, starting from the HV BOX address 00 until the last module.

The last HV BOX needs to be connected via CAN to the BMS Port of the Inverter.

**In HV, it is possible to connect up to 10 Clusters composed of 16 modules each.**

After composing the various clusters of the system by following the instructions on the previous pages, it will be necessary to set the addresses of each HV BOX starting from address 00 and continuing in sequence up to address 09.

**HV CLUSTERS CONNECTION STEPS**

1. Connect the last HV BOX with the HV HUB via the CAN PORT 2A of the end of series HV BOX and the CAN INPUT PORT of the HV HUB.
2. Set the DIP Switches of the HV HUB with the sequence 00000000.
3. Stack the HV HUB on top of the last cluster HV BOX.
4. Connect the HV HUB to the power PORT of the last HV BOX to power the HV HUB.
5. Connect the CAN PORT 2A from the last HV BOX to the CAN INPUT PORT of the HV HUB.
6. Connect the CAN/BMS PORT of the HV HUB to the Inverter BMS PORT (follow the inverter manual for PIN OUT of the CAN L/H position).
7. Initiate the HV CLUSTER Start-Up procedure by following the Single Cluster procedure for each cluster in the System.
8. To enable the HV Start-Up procedure, it is necessary to SWITCH ON the Main Breaker of the HV BOX. Before doing this, it is compulsory to inspect all the power connections of each cluster and the common HV bus bar.
9. All the SUB MODULES of each cluster will automatically WAKE UP after enabling the HV BOX main Breaker.
10. During the Cluster Start-Up process the HV HUB lighting will blink until the last cluster is completely turned on and all modules will display steady GREEN Light on the RUN BUTTON.

If one or more modules of the cluster does not come online, the cluster HV BOX will send a WARNING message to the HV HUB and the entire system will enter into IDLE MODE. To clear this status, it is necessary to inspect the modules that are causing the wake-up interruption, fix the error and repeat the entire Start-Up process from Step 1 (All HV BOXES must be Turned OFF and ALL Modules must be switched OFF before restarting the procedure).



**ATTENTION**

It is extremely important that every module within the system has the same voltage. The installation of an HV System is very complex and requires particular attention to the preparation of the individual modules that make up the cluster.

A single module with a voltage lower than a few mVolts compared to the others could generate a performance reduction of the entire system.

It is recommended to prepare each cluster with modules having voltage 53.5 +/- 0.2Vdc.



It's recommended to individually charge all modules at the same level before proceeding with the final installation.

### 3.7 HV Box ADDRESS

	HV BOX ADDRESS	DIP1	DIP2	DIP3	DIP4	DIP5	DIP6	DIP7	DIP8
	Adres after the setting	1	2	3	4	5	6	7	8
0	HV BOX Address 00	OFF	OFF	OFF	OFF	reserved	reserved	ON-with Terminal resistance OFF-no Terminal resistance	reserved
1	HV BOX Address 01	ON	OFF	OFF	OFF	reserved	reserved	ON-with Terminal resistance OFF-no Terminal resistance	reserved
2	HV BOX Address 02	OFF	ON	OFF	OFF	reserved	reserved	ON-with Terminal resistance OFF-no Terminal resistance	reserved
3	HV BOX Address 03	ON	ON	OFF	OFF	reserved	reserved	ON-with Terminal resistance OFF-no Terminal resistance	reserved
4	HV BOX Address 04	OFF	OFF	ON	OFF	reserved	reserved	ON-with Terminal resistance OFF-no Terminal resistance	reserved
5	HV BOX Address 05	ON	OFF	ON	OFF	reserved	reserved	ON-with Terminal resistance OFF-no Terminal resistance	reserved
6	HV BOX Address 06	OFF	ON	ON	OFF	reserved	reserved	ON-with Terminal resistance OFF-no Terminal resistance	reserved
7	HV BOX Address 07	ON	ON	ON	OFF	reserved	reserved	ON-with Terminal resistance OFF-no Terminal resistance	reserved
8	HV BOX Address 08	OFF	OFF	OFF	ON	reserved	reserved	ON-with Terminal resistance OFF-no Terminal resistance	reserved
9	HV BOX Address 09	ON	OFF	OFF	ON	reserved	reserved	ON-with Terminal resistance OFF-no Terminal resistance	reserved
10	HV BOX Address 10	OFF	ON	OFF	ON	reserved	reserved	ON-with Terminal resistance OFF-no Terminal resistance	reserved
11	HV BOX Address 11	ON	ON	OFF	ON	reserved	reserved	ON-with Terminal resistance OFF-no Terminal resistance	reserved
12	HV BOX Address 12	OFF	OFF	ON	ON	reserved	reserved	ON-with Terminal resistance OFF-no Terminal resistance	reserved
13	HV BOX Address 13	ON	OFF	ON	ON	reserved	reserved	ON-with Terminal resistance OFF-no Terminal resistance	reserved
14	HV BOX Address 14	OFF	ON	ON	ON	reserved	reserved	ON-with Terminal resistance OFF-no Terminal resistance	reserved
15	HV BOX Address 15	ON	ON	ON	ON	reserved	reserved	ON-with Terminal resistance OFF-no Terminal resistance	reserved

## MULTI CLUSTER CONNECTION WITH HIGH VOLTAGE HUB

### Installation of a High Voltage Multi-Cluster System.

1. Install clusters with the same number of modules. Each module of each cluster must have the same voltage. Each cluster must have the same total voltage.
2. Set the DIP switches of each HV Box with the addresses starting from ID 01 and continue in progressive sequence up to the last HV Box.
3. The last HV Box must be connected to the HV HUB device, placed above the last tower.
4. Connect all the communication cables between the various HV BOXES using the CAN PORT 1A and 2A and proceed as shown in the diagram below.
5. Connect the last HV BOX with the HV HUB device by connecting the CAN PORT 1A or 2A of the HV BOX with the CAN INPUT PORT located on the HV HUB.
6. Connect the CAN BMS PORT of the HV HUB device to the CAN PORT of the inverter following the inverter manufacturer PIN.
7. Power the HV HUB device with two high voltage cables from the parallel connection between the various clusters. The HV HUB device is powered with a minimum of 100V (max 1000V).

**Attention: Do not turn on the HV HUB device (power key kept off)**

8. After checking all high voltage power connections and making sure polarity is correct, visually check all connections by double-checking the manual.
9. Press the HV HUB power button.
10. Activate the first switch of the HV BOX ID01 and wait for the total start-up of the first cluster. Only when the first cluster is fully operational is it possible to proceed with the start-up procedure of the second cluster.
11. Wait for the complete start-up and then proceed with the same methodology for each cluster.
12. At this point, the start-up procedure is completed and the HV HUB device will initiate the control procedure of each single cluster by activating the HV HUB contactors one by one to prevent voltage spikes.
13. The start-up procedure foresees the deferred switching on of the various clusters with a delay of at least 5 seconds from each other.

### ATTENTION:

In a multi cluster system, only the HV BOX with address ID01 will close the circuit in order to power the HV HUB from the common bus bar. All the remaining HV BOXES will receive the input of closing the HV BOX contactor only when the entire cluster procedure is completed by the HV HUB.

HUB HV logic includes a voltage control algorithm that controls the consistency of each cluster before allowing the closing the HV BOX contactors.

The PC software will indicate any discrepancies that prevent installation.

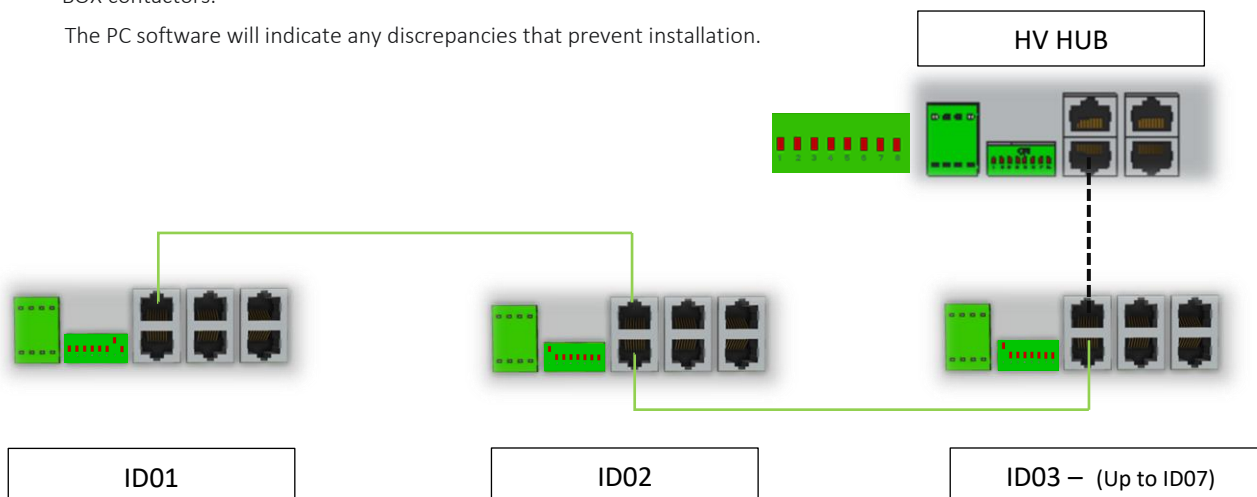

### 3.7.1 LED Visual Indication Lights

- RUN Button
- Each Battery Module has its own RUN button, however, when used with the HV Box during normal operation, the RUN button has no function and is bypassed by the control communications from the HV Box.



**Caution:** In the HV configuration, the RUN button will have no effect on the operation of the Battery Module and the operator should not assume that the RUN button will have switched off the Battery Module when pressed.

#### 3.7.1.1 Power Switch + Run Button

The Power Switch and the Run Button are located to the right of the battery terminal connections on the side of the Battery Module.

The RUN Button is a GREEN LED button and will provide the user with the following indications depending on the state of the battery.

**STARTUP:** Turn ON the Power Switch (1 = ON 0= OFF)

A 2-second press on the RUN Button will turn the Battery Module on.

During the startup procedure, the RUN button will blink until the safety inspection has been completed by the BMS.

**SHUTDOWN:** A 5-second press and hold on the RUN Button will turn the Battery Module off.

Turn OFF the Power Switch (1 = ON 0= OFF)

Other functions of the RUN Button are explained in the relevant sections of this manual.



**Attention:** Read this entire manual thoroughly to understand the correct startup and shutdown procedures for each battery configuration.



**Attention:** Illustrations shown are for reference only. Please always refer to the physical Battery Module in front of you, and if the module has a different configuration to this manual, stop all activity immediately and contact your Deka Duration technical representative.

### 3.7.2 Stand-Alone Battery Front Panel Control \* FORCED CHARGE\*

#### 3.7.2.1 Start Battery

Press the Power Button of the HV Box for 3 or more seconds (depends on the system status).

The GREEN RUN light should come on. The HV Box module has been activated normally and the Battery Modules should come on automatically. If they do not, press the RUN Button of each module and wait for the HV Box string diagnosis. If the HV Box shows a warning LED light (RED), turn the string OFF and connect the PC software for debugging.

#### 3.7.2.2 Shut Down Batteries and HV Box

Long press the RUN Button on the battery module for five seconds and the Run Button on the HV Box.

The GREEN RUN light should go off. The HV Box has been shut down normally.

By switching off the HV Box, all the Battery Modules should turn off automatically. If they do not turn off automatically, shut down manually by pressing and holding the Run Button on the battery module for 5 seconds.

Always completely shut down the system when performing a mechanical inspection.

### 3.7.2.3 Low Battery – Forced Charge



**ATTENTION:** The HV connection cables must be disconnected; the Forced Charge implies to follow the LV section rules.

**THE FORCED CHARGE MUST BE PERFORMED AS SINGLE LOW VOLTAGE MODULE.**

**THE MODULE MUST BE DISCONNECTED FROM THE HV STRING.**

SET THE MODULE DIP SWITCH AS PER THE PICTURE BELOW



**ATTENTION:** Before performing any operation on the Battery Module, make sure that the **VOLTAGE** between the battery B+ and B- terminals in the terminal BLOCK LOW VOLTAGE SECTION is **ZERO (0 Vdc)** and the **PANEL LIGHTS ARE OFF**.

Battery Module is in “Shutdown State,” only after the charging device is connected. The operator can turn on the battery by pressing the Run Button.

**Each Battery Module must be electrically isolated from other Battery Modules. All serial connections cables must be removed.**

**Preparation condition before Forced Charging:** Connect a 60 Vdc 50A charger to the B+ and B- terminal of the of the Battery Module to ensure charging.

**Forced Charging approach:** Short press the Battery Module RUN Button, the RUN light will flash GREEN which means that the battery is entering the compulsory charging mode. If the battery receives an adequate charging power (above 10 Amps/58V) within 90 seconds from pressing the button, the battery will continue to charge normally until a stable state is reached.

If the battery does not receive adequate charging power within 90 seconds after pressing the RUN button, the battery will enter the shutdown mode once again.

During the Forced Charging period, the FRONT LED BAR low battery LED will be steady orange up to an SoC of 10% at which point the FRONT LED BAR low battery LED will go out. Details of the indications on the FRONT LED BAR can be found in Section 2.5.5 of this manual.









**ATTENTION:** Each Battery Module must be recharged at the same SoC. The inspection must be done by using the Deka Duration RS232 and LV PC software.

This process could take some time and will require either a portable PC or handheld computer device.



**ATTENTION:** When the charging process of each module has been concluded, the serial connection must be restored by following this manual’s instructions.

### 3.8 HIGH VOLTAGE INVERTER COMPATIBILITY

INVERTER BRAND		MODEL	HV BOX Protocol Selection
	ZCS Azzurro	HYD ThreePhase ALL	WeCo CAN
	Sermatec	SMT ThreePhase ALL	WeCo CAN
	Tsun	TSOL HV single Phase	WeCo CAN
	Megarevo	ThreePhase ALL	WeCo CAN
	Solis	5G-K ThreePhase HV ALL	SOLIS CAN
	Ingeteam	PLAY HV	Ingeteam CAN HV

#### CAN PIN DEFINITION FOR HV INVERTERS

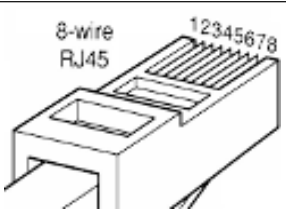
	CAN TERMINAL	Inverter Terminal Type	Invertr Side (PIN Number)	Battery Side (PIN Number)
<b>ZCS THREEPHASE</b>	CAN L	SCEW TERMINAL	7	2
	CAN H		8	1
	GND		/	3
<b>SOLIS HV</b>	CAN L	RJ45	5	2
	CAN H		4	1
	GND		2	3
<b>TSUN HV</b>	CAN L	RJ45	5	2
	CAN H		4	1
	GND			3
<b>INGETEAM PLAY HV</b>	CAN L	Inner Terminal	CAN H	1
	CAN H		CAN L	2
	GND		/	3
<b>SERMATEC HV</b>	CAN L	SCREW TERMINAL	CAN H	1
	CAN H		CAN L	2
	GND		/	3

H  
I  
G  
H  
  
V  
O  
L  
T  
A  
G  
E

### 3.9 WECO BMS - LOW VOLTAGE PC SOFTWARE for DD5300

#### LOW VOLTAGE SECTION

##### Equipment List:

PC Windows 10+Service pack 3.5 or above  
 RS232 Serial Converter with 232-RJ45 Plug  
 WeCo Monitor PC-SOFTWARE

#### PIN OUT RS232 CONVERTER

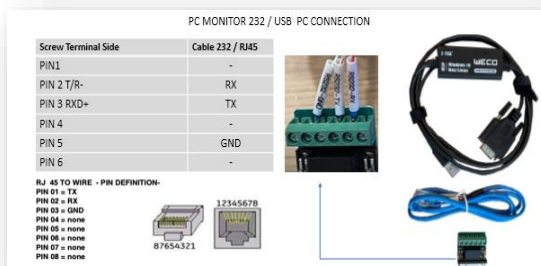

**STEP 1** Download the latest version of the WeCo BMS PC software at [www.DD5300-BMS.com](http://www.DD5300-BMS.com).

Enter the password: **1010**

Click: Operator Access to run the program in -Operator Mode-



**STEP 2** Select the Single Module Setting Program after pressing OPERATOR ACCESS Button.

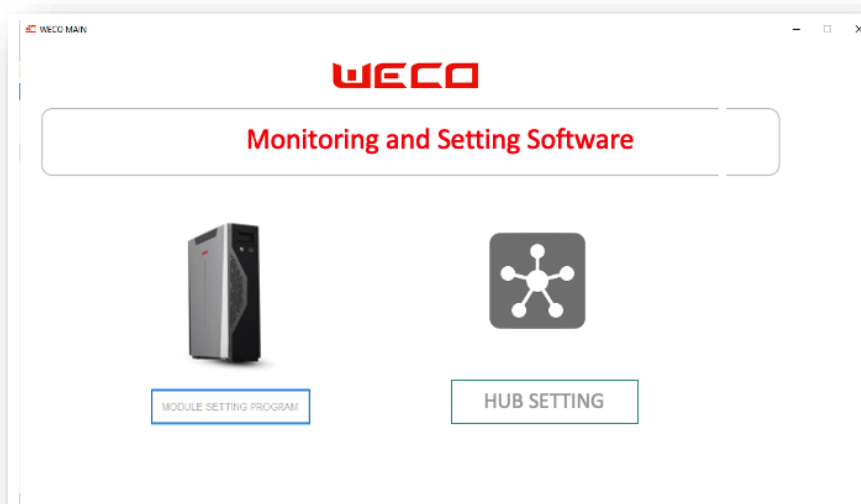



**STEP 3 Connect the RJ45 plug from the RS232-USB Converter to the Operator Port of the Battery Module.**

Operator Port is located on the battery side, near the RUN button.

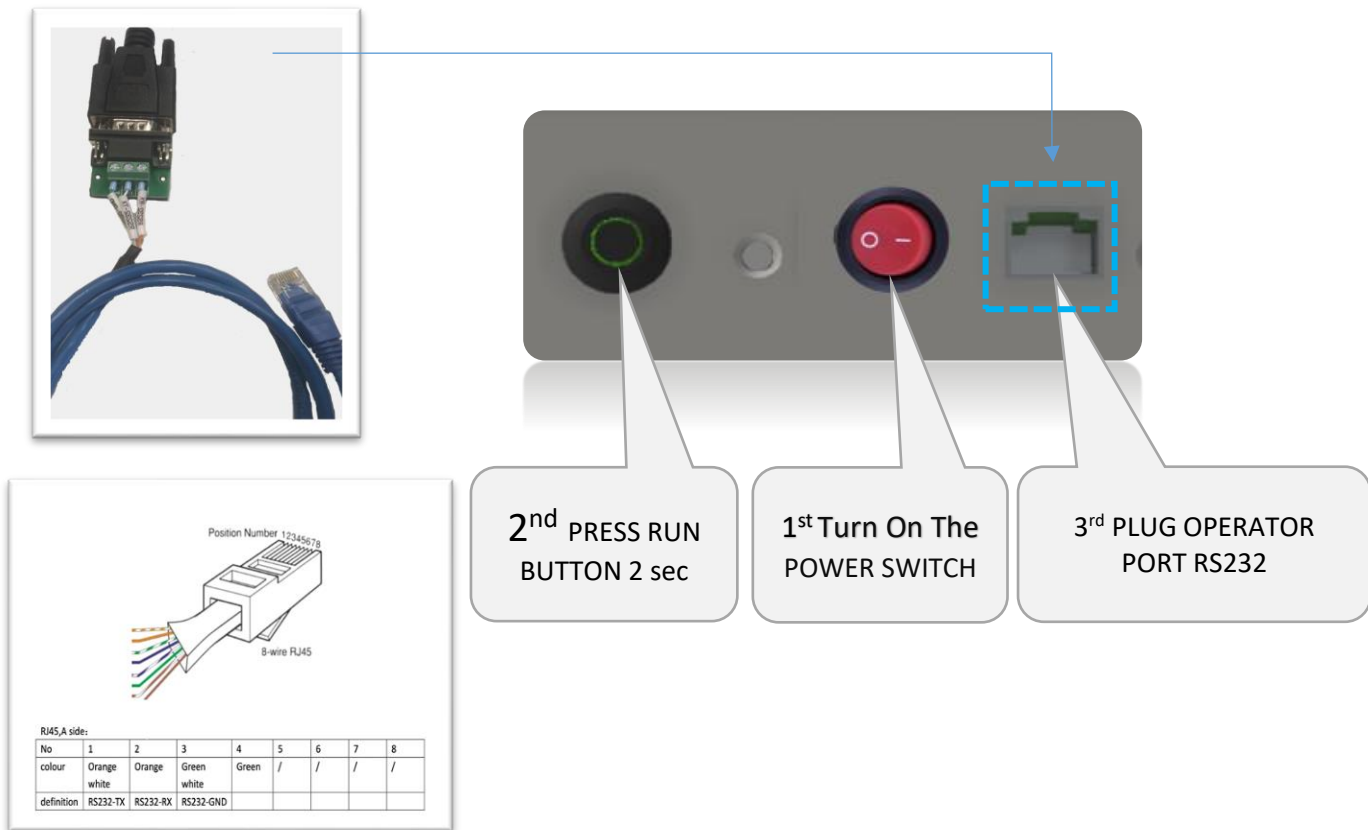

**STEP 4 Select the COM PORT from the PC Software.**

(Check the USB Port Number from the Microsoft Windows – Device Manager Page)  
Turn ON the Battery Module and press the CONNECT BUTTON

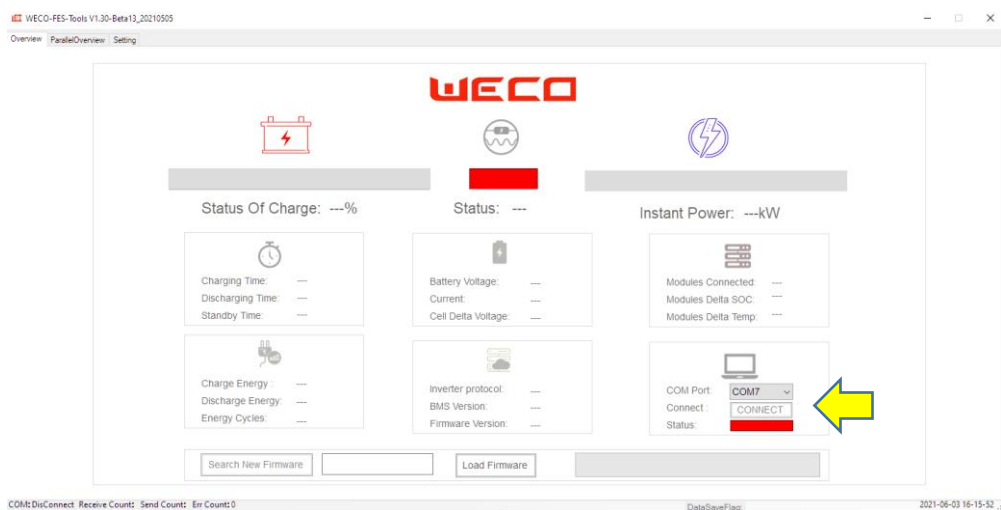

**STEP 5** When the communication is established between the PC and the Battery Module, the PC software will display a page like the one below:



If more than one battery is connected in parallel, all the information will be displayed on this page. These pages will automatically update for up to 15 modules.

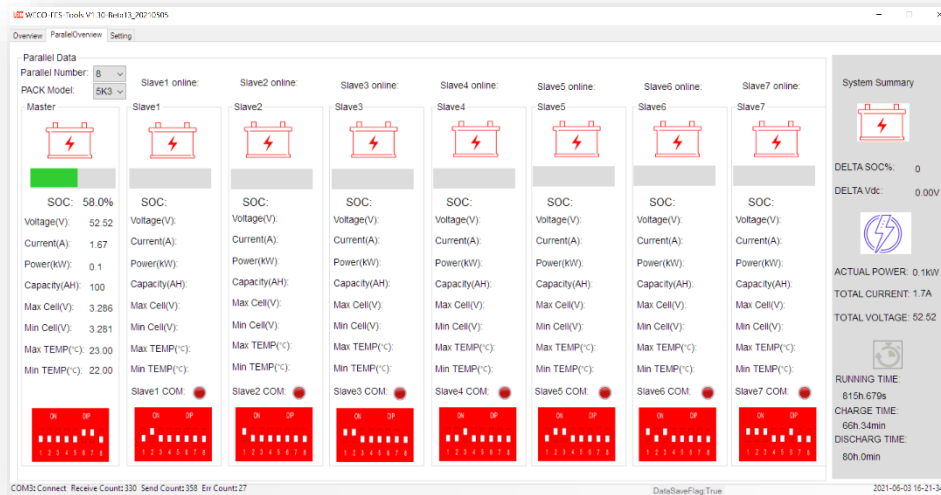

Select the applicable number of batteries that are composing your cluster.

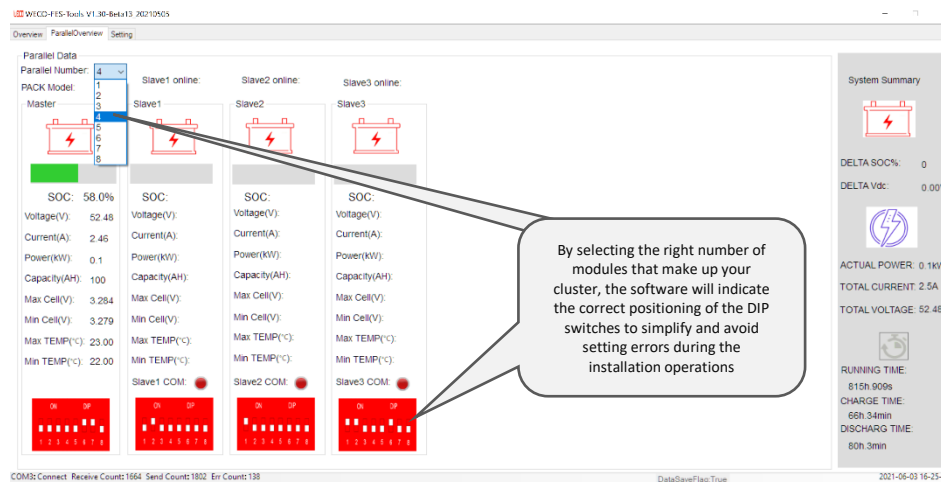

**STEP 6 LOW VOLTAGE PROTOCOL MODIFICATION**

In order to connect the battery with an inverter other than the default one, it is necessary to access the SETTING page and select the CAN protocol needed to communicate with the inverter.

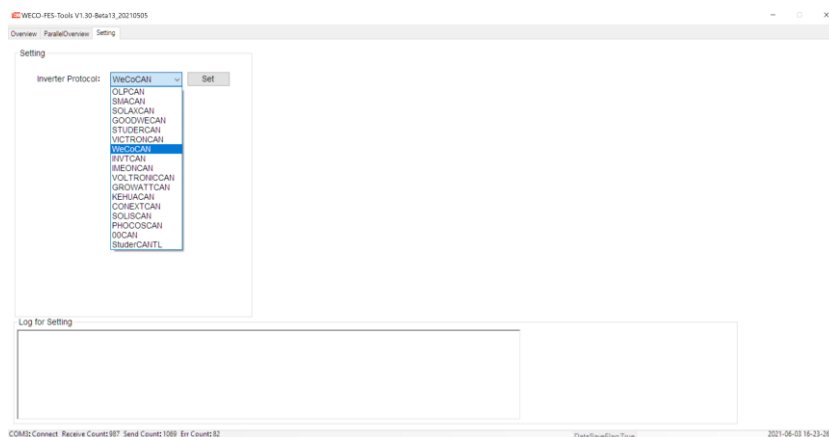

**STEP 7 FIRMWARE UPGRADE**

To update the firmware to a more recent version, it is necessary to download the latest version of the WeCo BMS software at [www.DD5300-BMS.com](http://www.DD5300-BMS.com) and install it from the software as indicated.

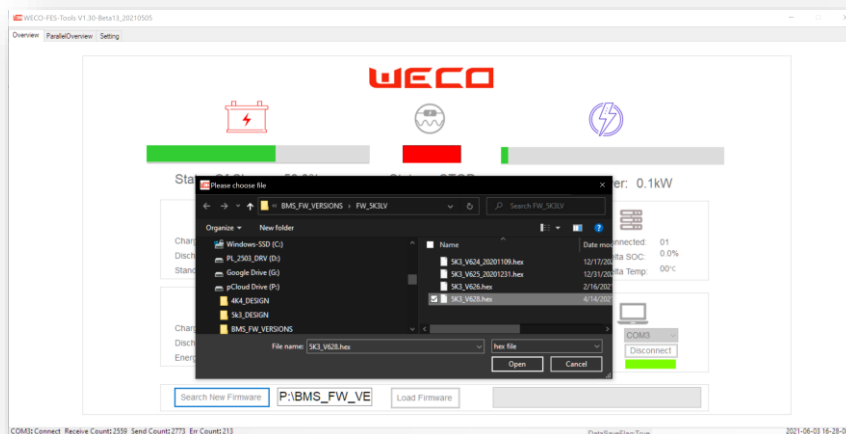

Make sure that the connection between the battery converter and the PC is stable for the duration of the update process. Do not disconnect the connection before the software has confirmed the upgrade.

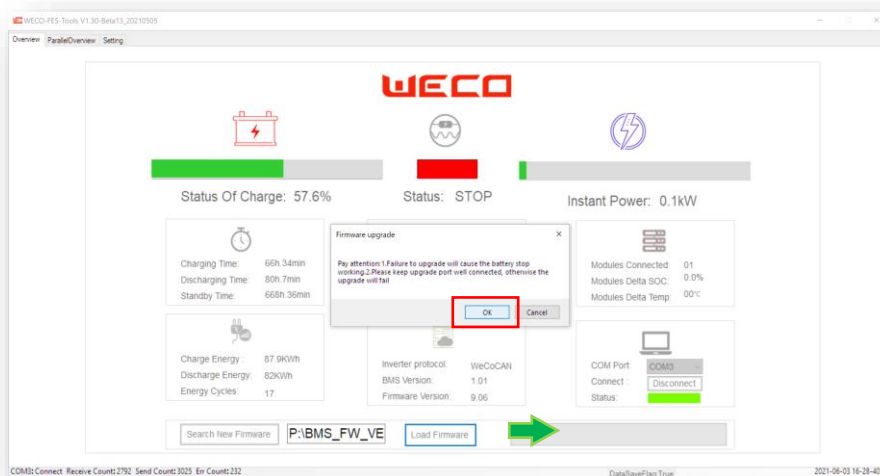

### 3.10 WECO BMS - HIGH VOLTAGE PC SOFTWARE for DD5300

Use an Opto-Isolated RS232-USB Converter for the connection between PC and HV BOX.

**STEP 1** Connect the RJ45 Port with the Operator Port located in the front of the HV BOX.  
**TURN ON THE MAIN BREAKER**

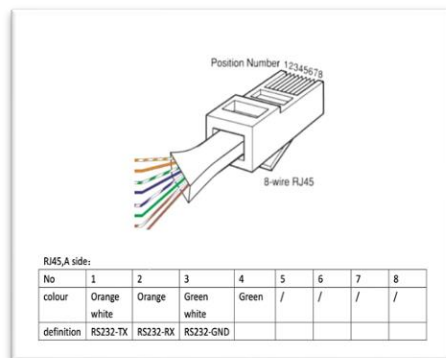
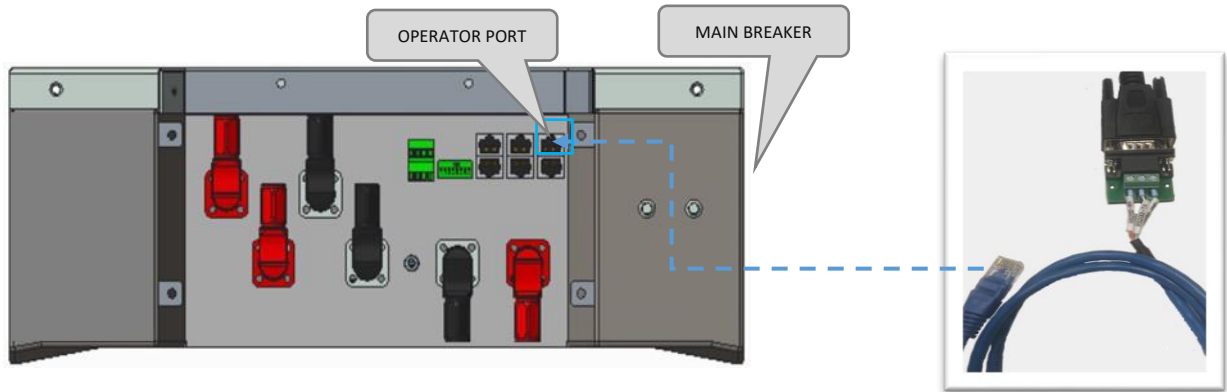

**STEP 2** Select the COM PORT and press CONNECT.

After the communication is established correctly, the PC software will display the system general information as shown below:

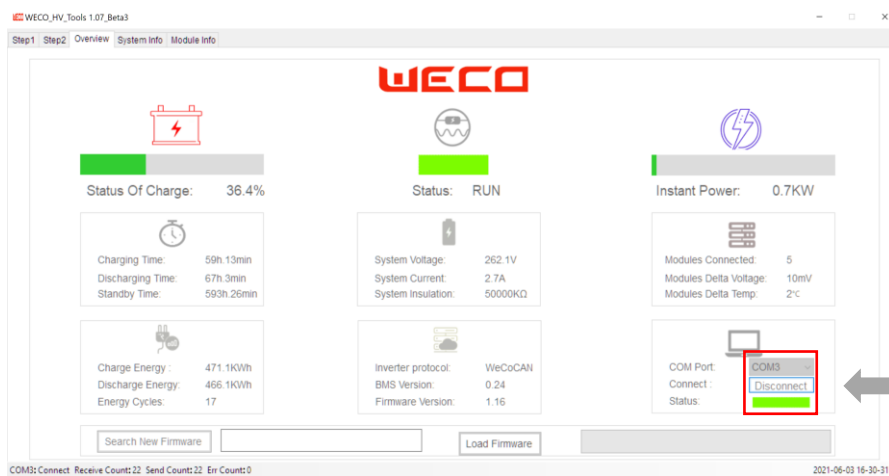

**STEP 3 SYSTEM INFORMATION**

From this page it is possible to view the modules that make up the system. It is also possible to monitor the voltage and current status of each individual module and any warnings or alarms.

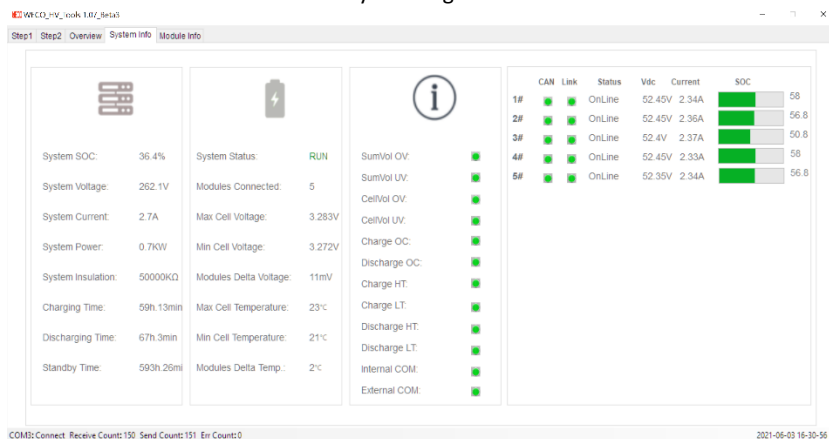

**STEP 4 MODULE INFORMATION**

From this page it is possible to view the individual cells of each module by selecting the desired module at the bottom of the screen.

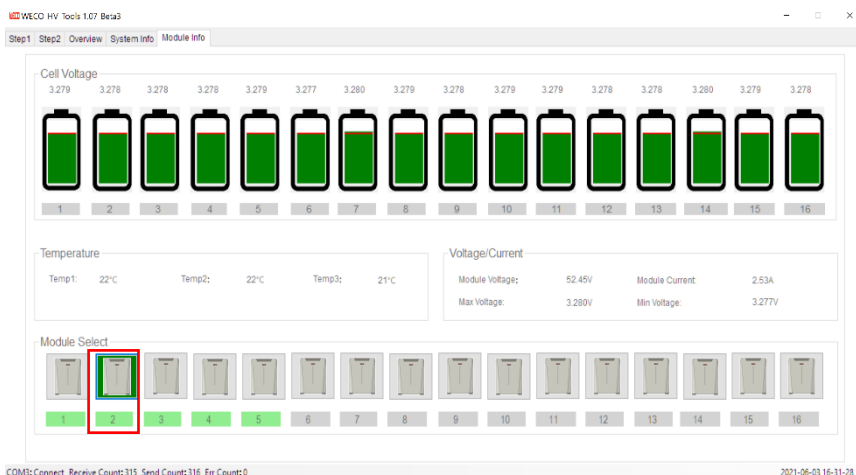

**STEP 5 HV BOX FIRMWARE UPGRADE**

By selecting the SEARCH NEW FIRMWARE, it is possible to search for the new HV BOX Firmware available (visit [www.DD5300-BMS.com](http://www.DD5300-BMS.com) to find the latest version). After selecting the file, press LOAD FIRMWARE to launch the Firmware Upgrade.

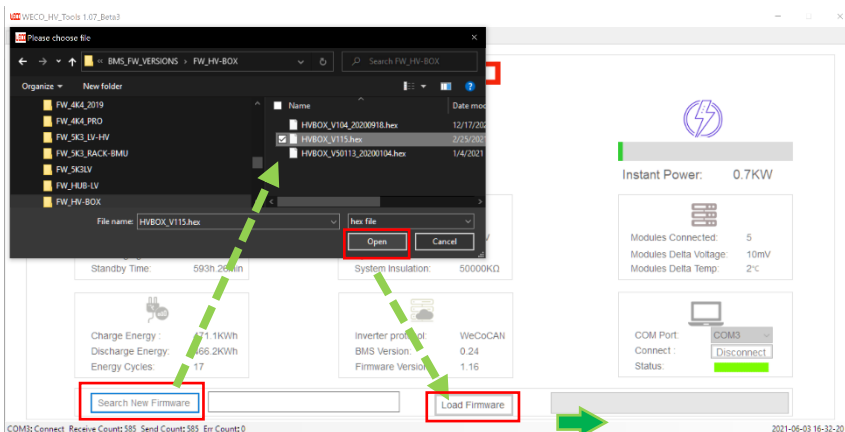

After confirming the File and clicking on the LOAD FIRMWARE button, the update procedure will begin and the HV BOX will be updated to the latest version.

The internal contactor may open and close several times after the update procedure is completed.

**MOBILE Bluetooth APP**

Install the WECO LOCAL App by downloading it from the App Store / Google Play - available in 2022

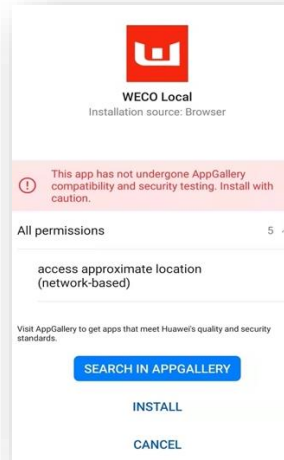
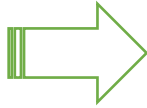
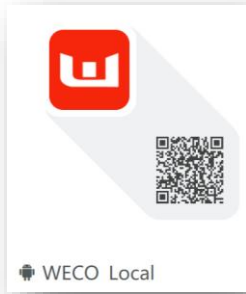

Install the APK file from your File Folder

**MOBILE APP GENERAL OVERVIEW + FIRMWARE UPGRADE**  
Operator Access

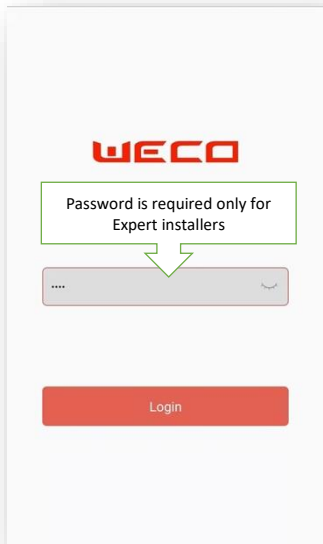

Password is required only for Expert installers

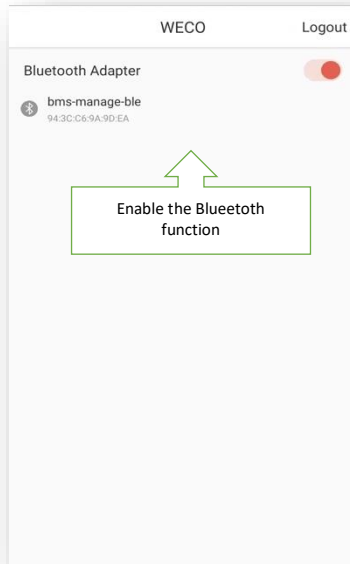

Enable the Bluetooth function

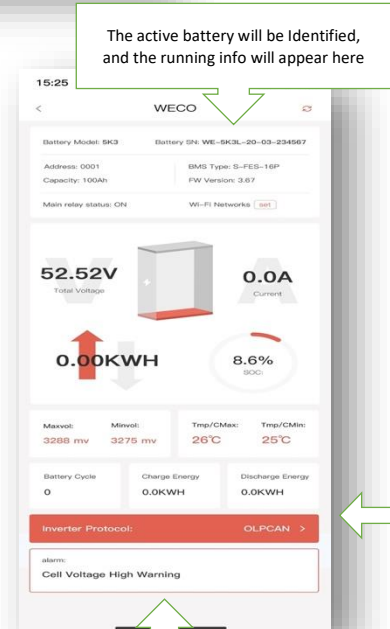

The active battery will be identified, and the running info will appear here

To Change BMS Protocol press here

Running Alarms or Warns will appear here

Software upgrade

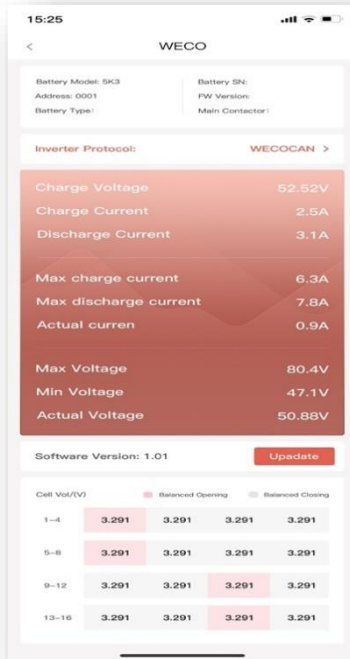



**ATTENTION:** The charge and discharge current of the inverter **MUST** be limited according to the maximum current allowed by each cluster configuration.

The charge and discharge voltage range of the inverter **MUST** be limited as per the Battery Module maximum value.



**NOTE:**

All data subject to change without notice. No part of this document may be copied or reproduced, electronically or mechanically, without written permission from the company.

Before installing your Deka Duration Battery Modules, please contact your Deka Duration representative for the latest manual and any additional support.



1-800-372-9253 • 714-937-1033 • [mkbattery.com](http://mkbattery.com)

Email: [durationsupport@dekabatteries.com](mailto:durationsupport@dekabatteries.com)

***MK Battery – An East Penn Manufacturing Co. Subsidiary***

All data subject to change without notice. Actual product color may vary. No part of this document can be copied or reproduced, electronically or mechanically, without written permission from the company. permission from the company. permission from the company.  
E.P.M. Form No. 2593 Rev. 11/21 ©2021 by EPM Printed in U.S.A.